

STU udio uce



Catálogo 2023

vestir
espaços
de luz,
design
e emoção.

Acreditamos na importância de iluminar espaços com originalidade, por isso, investimos cada vez mais no desenvolvimento de soluções exclusivas que entregam, além do design, emoções através da luz.

O time de Pesquisa & Desenvolvimento da Studioluce trabalha em sintonia com referências e tendências internacionais, garantindo as melhores soluções em iluminação decorativa.

STUDIOLUCE

Em 07 de abril de 1995, atuando como fábrica de luminárias decorativas de alto padrão com direção criativa dos designers Toni e Marco Dias, começa a história da Studioluce. Referência em qualidade e design, por inúmeras vezes foi reconhecida pela excelência e recebeu prêmios como: Prêmio Design MCB, conferido pelo Museu da Casa Brasileira, Prêmio Abilux Design de Luminárias e o renomado prêmio internacional iF Design Award, entre outros.

A partir de 2007, a Studioluce – mantendo sua missão na fabricação de luminárias – passa a integrar o Grupo Newline, e nesse período foi responsável por iluminar vários edifícios ícones da arquitetura contemporânea como os hotéis Hilton, Sheraton, Transamérica, Emiliano, Renaissance e Unique, além dos hospitais Albert Einstein e Sírio Libanês, na capital paulista.

Em 2012, iniciamos a atuação no desenvolvimento e criação de luminárias importadas garantindo qualidade e acabamento diferenciados das peças e essa visão e cuidado nos trouxe até aqui.

Hoje a Studioluce conta com um portfólio com mais de 1.000 soluções em iluminação decorativa. Além de pendentes, arandelas, plafons e abajures que entregam luz aos espaços. Nossos produtos levam design e identidade por meio da iluminação disruptiva.

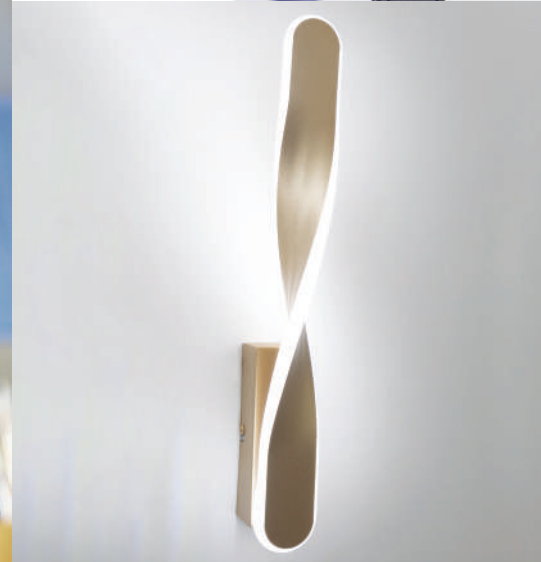
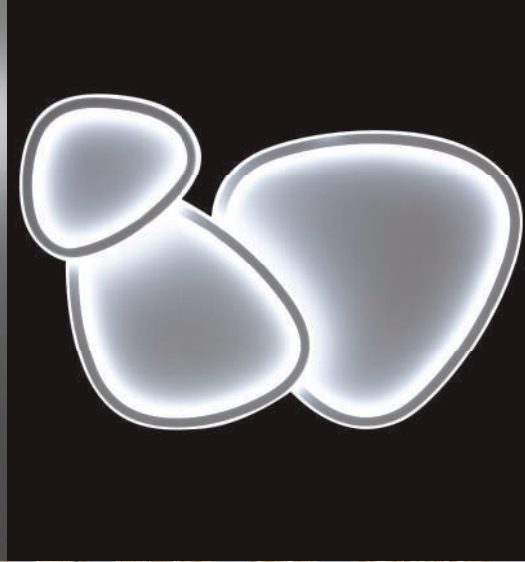



SHOWROOM

O Showroom Studioluce – instalado em um espaço de 1.000m², distribuídos em 3 pavimentos – fica em São Paulo, próximo ao Aeroporto de Congonhas em um local de fácil acesso. Idealizado como um espaço de experiência, o showroom está sempre preparado para receber clientes e parceiros tanto para workshops, treinamentos e eventos, quanto para um simples café e um bate papo.

No rooftop, um amplo espaço Gourmet funcional foi idealizado para tornar a experiência ainda mais agradável aos visitantes; aliando toda experiência com um toque sensorial que nos convida a saborear a vida com mais calma.

Endereço: Rua Guaraiúva, 447 - Brooklin - São Paulo - SP.
CEP: 04569-000



CENTRO DE DISTRIBUIÇÃO

No centro de distribuição Studiolute, localizado em Suzano, São Paulo, implementamos os mais modernos formatos de gerenciamento de estoque, armazenagem, controle de qualidade e distribuição. Com processos estratégicos e inteligentes, garantimos maior eficiência nos prazos e nas entregas dos nossos produtos.

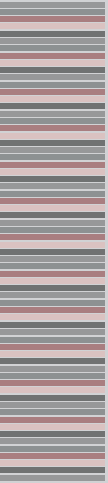

NOVA COLEÇÃO 2023

Com o propósito de vestir ambientes de luz, design e emoção, a Coleção 2023 Studioluze, reflete a força, elegância e beleza do Feminino. São mais de 100 novas peças que imprimem originalidade e elegância, assim como nossa fonte de inspiração.



Prince
Pág.15



Tarta
pág.17

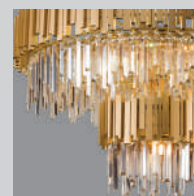

Carlota
pág.21

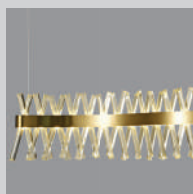

Hort
pág.25



Mali
pág.29



Lanciato
pág.33

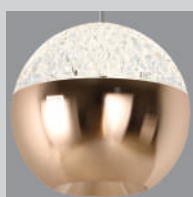

Bol
pág.51

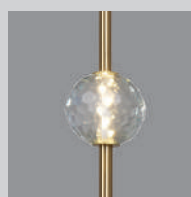

Nó
pág.65



Frida
pág.85





Cora
pág.89



Véu
pág.95



Namastê
pág.97



Alma
pág.99



Traço
pág.101

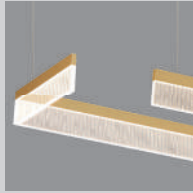

Tomie
pág.103



Candela
pág.105



Lamar
pág.117



Onna
pág.149



Onde
pág.169



Malala
pág.171



Valley
pág.180



Gaia
pág.183



Volta
pág.199



Maré
pág.200



Numa
pág.201



Numa
pág.203



Baba
pág.219



Disco
pág.221



Coco
pág.223



Friso
pág.235



Passo
pág.237



Muvuca
pág.305



Fita
pág.421



Onda
pág.424



Mimo
pág.429



Deja Vu
pág.430

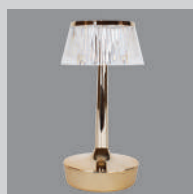

Auê
pág.431



Dengo
pág.433



Mia
pág.435



Zuzu
pág.436



Poti
pág.437



Indira
pág.447



Kon
pág.449



Rustic
pág.467

INDEX

alfabético de familias

Allure	173	Castillo	37	Friso	235
Alma	99	Cissy	131	Full Moon	307
Anello	123	Clam	348	Fusion	175
Anello Oval	127	Classic	354	Gaia	183
Aniko	375	Cloud	303	Gali	57
Antik	67	Cloud II	301	Globe	404
Arrow	398	Cluster	399	Haken	39
Asha	227	Coco	223	Halter	417
Askin	380	Colli	261	Hamar	389
Atenas	93	Cora	89	Haus	376
Atomy	249	Cosmos	247	Hazel	59
Auê	430	Cover	416	Helmet	388
Augen	361	Cozy	374	Hilton	356
Aura	243	Crown	35	Hook	285
Avis	215	Cúpulas de Abajur	467	Hoop	209
Baba	219	Cutie	342	Horn	390
Balka	129	Deja Vu	429	Hort	25
Bases de Abajur	446	Dengo	432	Horus	56
Bead	336	Deuce	335	Hunt	252
Beaver	382	Diamond	45	Ivory	406
Bergen	384	Disco	221	Jadore	61
Berla	229	DNA	251	Jetty	345
Bert	185	Dock	115	Jubile	412
Blade	137	Dome	363	Kane	328
Blasen	245	Dover	225	Kiev	402
Blur	55	Drain	364	Kira	213
Bol	51	Drain Office	370	Kono	427
Brande	386	Drip	346	Krio	424
Cadre	330	Dublin	350	Lace	205
Cálico	352	Dupe	231	Lamar	117
Calla	217	Eclipse	165	Lamu	318
Candela	105	Eden	344	Lance	109
Cannon	153	Fita	420	Lanciato	33
Canopla Slim para Gesso	468	Flint	438	Land	23
Carlota	21	Frida	85	Laticius	49

Lina	106	Orbit II	275	Tagne	208
Linse	360	Orbit Mondri	289	Tarta	17
Lockup	410	Orgon	197	Tear	347
Lolly	313	Orla	425	Tine	405
Lorum	111	Passo	237	Tint	440
Ludo	159	Pectus	163	Toak	13
Luft	232	Pellet	358	Tomie	103
Lune	107	Pinot	253	Torch	400
Luxor	41	Pipe	378	Torchia	340
Lynus	43	Plyn	311	Trace	401
Malala	171	Post	41	Traço	101
Mali	29	Poti	436	Triplet	326
Mallen	177	Potter	440	Turret	443
Manner	409	Prince	15	Twine	207
Maré	200	Quebec	191	Valley	179
Maya	53	Rafik	187	Vega	362
Mia	434	Ravelo	338	Vermont	318
Mimo	428	Ricci	241	Verona	445
Mini Moon	319	Ritz	167	Versa	91
Mizo	426	Roof	379	Véu	95
Mob	233	Sears	155	Vision	377
Montreal	195	Shell	11	Volpi	211
Moon	320	Sicília	444	Volta	199
Muvuca	305	Sion	63	Wala	119
Namastê	97	Sling	413	Worm	206
Neolus	259	Somut	414	Zavo	113
Nexus	387	Sonik	161	Zenet	31
Nice	408	Sophi	69	Zione	141
Nó	65	Space	239	Zuzu	435
Numa	201	Spine	396		
Ohana	309	Spire	359		
Onda	422	Spring	351		
Onde	169	Spy	287		
Onna	149	Suez	71		
Orbit	265	Tack	442		

Shell

Estrutura: Metal / Vidro
Acabamento: Dourado

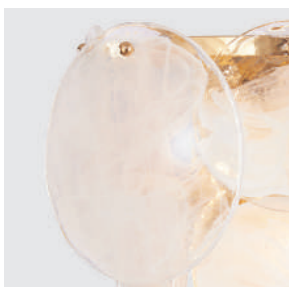

Detalhe do vidro



● **AR1696**
Arandela

3x G9 Halopin LED 5W
Dimensões: 320x210xA210mm
Tensão: Bivolt (127V/220V)
Potência máxima: 15W



● **PD1697**
Pendente

21x G9 Halopin LED 5W
Dimensões: Ø750 x A330 mm
Tensão: Bivolt (127V/220V)
Potência máxima: 105W
Cabo ajustável até 2000 mm



● **PD1698**
Pendente

10x G9 Halopin LED 5W
Dimensões: C1200 x L150 x A150 mm
Tensão: Bivolt (127V/220V)
Potência máxima: 50W
Cabo ajustável até 2000 mm



PD1698

Toak

Estrutura: Metal/Vidro
Acabamento: Dourado

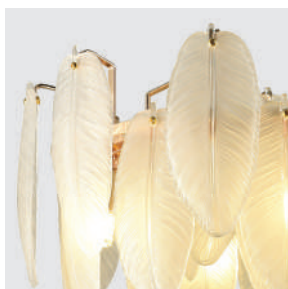

Detalhe do vidro



● **PD1731**
Pendente

10xG9 Halopin LED 5W
Dimensões: C1000 x L380 x P230 mm
Tensão: Bivolt (127V/220V)
Potência máxima: 50W



PD1731

Prince

Metal | Vidro | Dourado e Transparente

LANÇAMENTO • 2023



Detalhe da peça



● **PD1773**
Pendente

22XG9 | 110W MAX
D700XA450mm
Bivolt

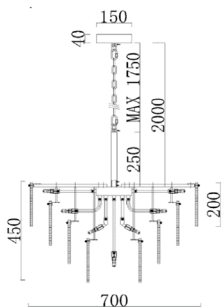

Cabo ajustável até 2000mm



Detalhe da peça



● **PD1774**

Pendente

16XG9 | 80W MAX
C1000XL300XA300mm
Bivolt

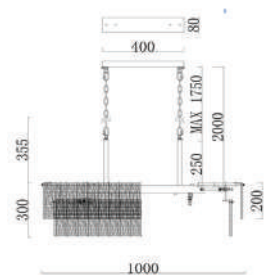

Cabo ajustável até 2000mm

Tarta

Metal Vidro | Dourado fosco



Detalhe da peça



● **PD1730**

Pendente

12XG9 | 60W MAX
C1000XL350XA400mm
Bivolt

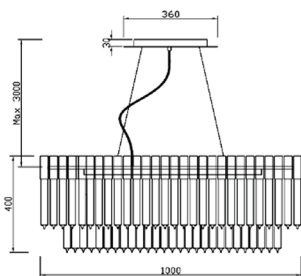

Cabo ajustável até 3000mm



PD1730

Tarta

Estrutura: Metal / Vidro
Acabamento: Dourado fosco



● **PD1728**
Pendente

15xG9 Halopin LED 5W
Dimensões: Ø800 x A460 mm
Tensão: Bivolt (127V/220V)
Potência máxima: 75W
Cabo ajustável até 2000 mm



PD1728

Carlota

Metal e Alumínio | Cristal | Dourado e Transparente

LANÇAMENTO • 2023



Detalhe da peça

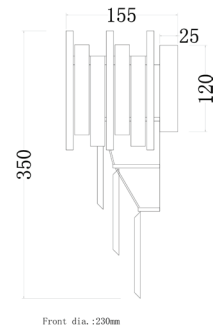

● **AR1804**
Arandela

2XG9 | 10W MAX
C155XL230XA350mm
Bivolt

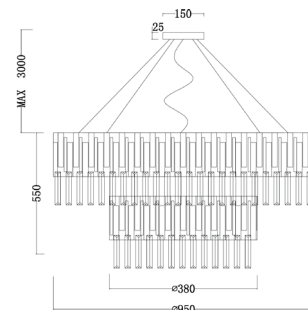

● **PD1806**
Pendente

19XG9 | 95W MAX
D950XA550mm
Bivolt

Cabo ajustável até 3000mm

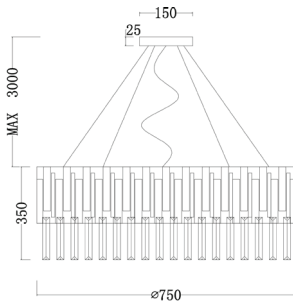

Cabo ajustável até 3000mm



● **PD1805**
Pendente

10XG9 | 50W MAX
D750XA350mm
Bivolt

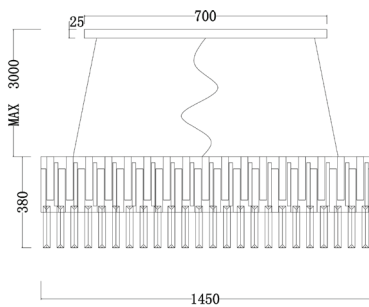

Cabo ajustável até 3000mm



● **PD1882**
Pendente

14XG9 | 70W MAX
C1450XL300XA350mm
Bivolt

Land

Estrutura: Metal / Vidro

Acabamento: Preto (onix) ou dourado fosco



- PD1729
 - PD1729DO
- Pendente

LED 44W
Lúmens: 2640lm
Temperatura de cor: 3000K
Dimensões: Ø700 x A150 mm
Tensão: Bivolt (127V/220V)
Potência máxima: 44W
Cabo ajustável até 2000 mm



PD1729

Hort

Metal | Vidro | Bronze e Transparente

LANÇAMENTO • 2023



Detalhe da peça

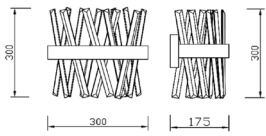

● **AR1783**
Arandela

4XG9 | 20W MAX
C300XL175XA300mm
Bivolt



● **PD1784**
Pendente

1XLED | 50W | 3500LM | 3000K
C1000XL160XA250mm
Bivolt

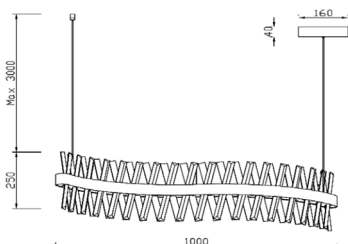

Cabo ajustável até 3000mm



PD1784

Hort

Estrutura: Metal / Vidro
Acabamento: Dourado escovado



● **PD1732**
Pendente

LED 38W
Lúmens: 2280lm
Temperatura: 3000K
Dimensões: Ø600 x A245 mm
Tensão: Bivolt (127V/220V)
Potência máxima: 37W
Cabo ajustável até 2000 mm



● **PD1733**
Pendente

LED 60W
Lúmens: 3600lm
Temperatura: 3000K
Dimensões: Ø1000 x A245 mm
Tensão: Bivolt (127V/220V)
Potência máxima: 60W
Cabo ajustável até 2000 mm



PD1733

Mali

Metal | Vidro | Dourado e Transparente

LANÇAMENTO • 2023

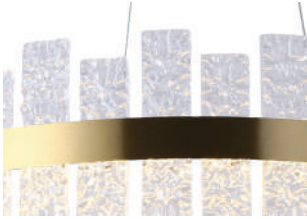

Detalhe da peça

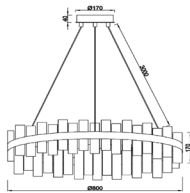

Cabo ajustável até 3000mm



● **PD1799**
Pendente

1XLED | 33W | 2310LM | 3000K
D800XA170mm
Bivolt

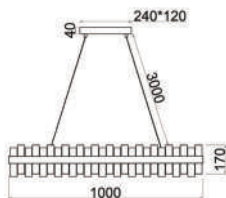

Cabo ajustável até 3000mm



● **PD1800**
Pendente

1XLED | 32W | 2240LM | 3000K
C1000XL300XA170mm
Bivolt



LANÇAMENTO • 2023

PD1799

Zenet

Estrutura: Metal/ Cristal

Difusor: Cristal

Acabamento: Dourado

● **PD1650DO**
Pendente

LED 23W
Lúmens: 1840lm
Temperatura: 3000K
Dimensões: C1200 x L36 x A76 mm
Tensão: Bivolt (127V/220V)
Potência máxima: 23W
Cabo ajustável até 1500 mm

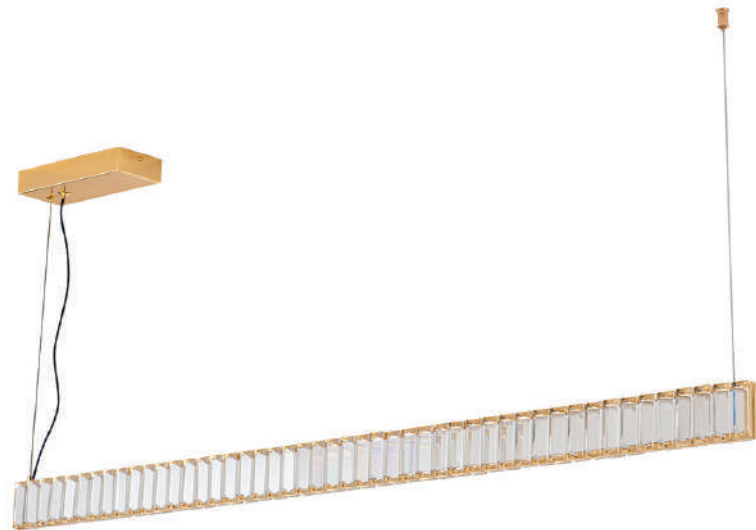

● **PD1651DO**
Pendente

LED 60W
Lúmens: 4800lm
Temperatura: 3000K
Dimensões: C1200 x L250 x A76 mm
Tensão: Bivolt (127V/220V)
Potência máxima: 60W
Cabo ajustável até 1500 mm





PD1651DO

Lanciato

Metal | Cristal | Dourado e Transparente

LANÇAMENTO • 2023



Detalhe da peça

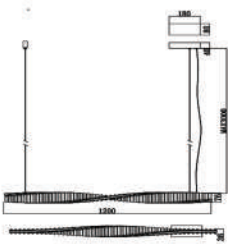

Cabo ajustável até 3000mm



● **PD1767**
Pendente

1XLED | 20W | 1600LM | 3000K
C1200XL36XA76mm
Bivolt



● **PD1768**
Pendente

1XLED | 12W | 1020LM | 3000K
L76XA600mm
Bivolt

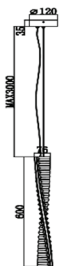

Cabo ajustável até 3000mm



● **PD1769**
Pendente

1XLED | 20W | 1600LM | 3000K
L76XA1200mm
Bivolt

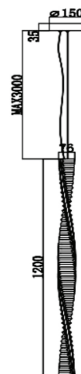

Cabo ajustável até 3000mm



PD1767



● **AR1770**
Arandela

1XLED | 10W | 800LM | 3000K
C80XL117XA500mm
Bivolt

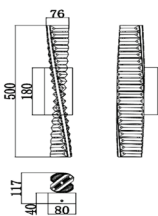

● **AR1771**
Arandela

1XLED | 20W | 1600LM | 3000K
C80XL117XA1000mm
Bivolt

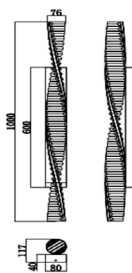

Crown

Estrutura: Metal

Difusor: Acrílico

Acabamento: Dourado

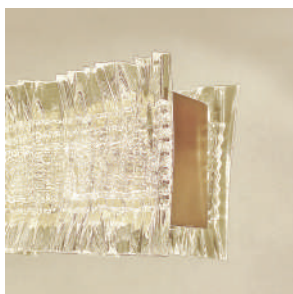

● **AR1709**

Arandela

LED 9W

Lúmens: 630lm

Temperatura: 3000K

Dimensões: C260 x A70 mm

Tensão: Bivolt (127V/220V)

Potência máxima: 9W



● **PL1710**

Plafon

LED 62W

Lúmens: 4340lm

Temperatura: 3000K

Dimensões: Ø630 x A70 mm

Tensão: Bivolt (127V/220V)

Potência máxima: 62W



● **PD1711**
Pendente

LED 85W
Lúmens: 5950lm
Temperatura: 3000K
Dimensões: C1200 x L60 x A70 mm
Tensão: Bivolt (127V/220V)
Potência máxima: 85W
Cabo 1500 mm

Castillo

Estrutura: Metal

Cristais decorativos com ajuste de posição

Acabamento: Marrom



Sistema magnético para fixação/ajuste dos cristais



- AR1456
 - AR1456DO
 - AR1456PT
- Arandela

LED 8W / 680 lm / 3000K
 Dimensões: C250 x A140 mm
 Cristais: A80 + A100 + A120 + A140 mm
 Tensão: Bivolt (127V/220V)

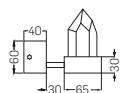

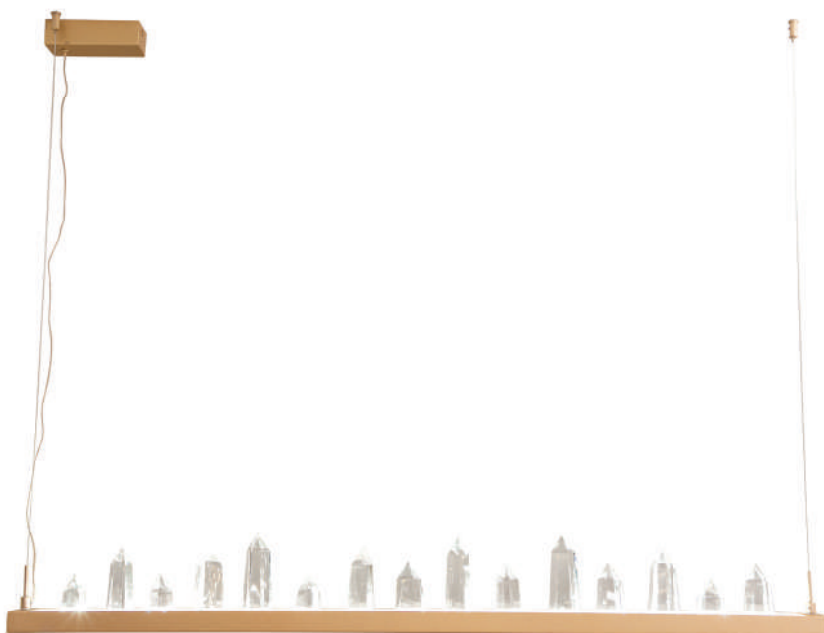
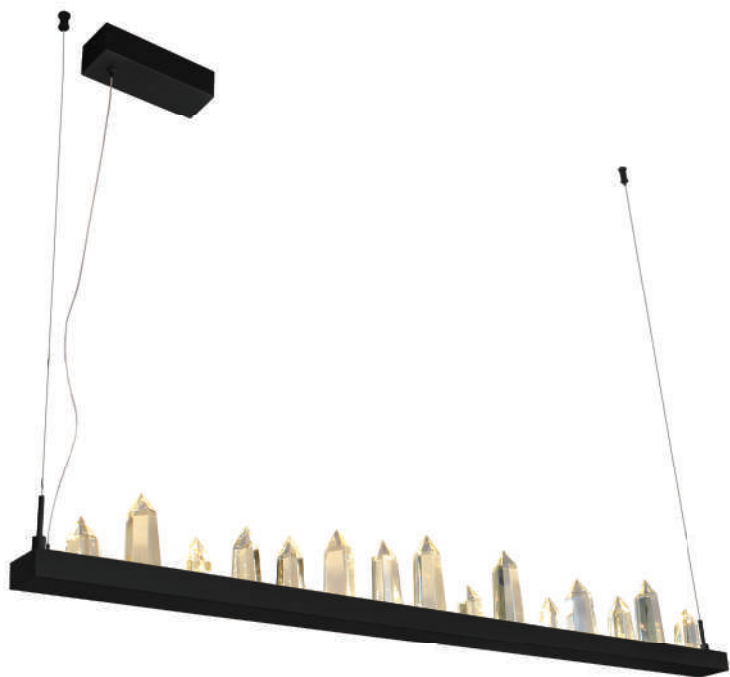

- PD1455
 - PD1455DO
 - PD1455PT
- Pendente*

LED 36W / 3060lm / 3000K
Dimensões: C1200 x A140 mm
Cristais: 4xA80 + 4xA100 + 4xA120 + 3xA140 mm
Tensão: Bivolt (127V/220V)
Cabo ajustável até 1,50 m

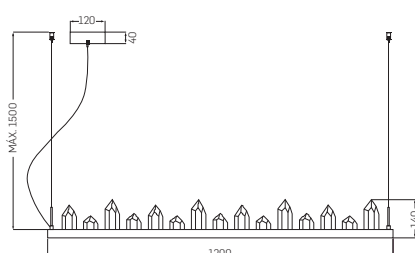

Haken

Estrutura: Metal

Difusor: Cristal de rocha / Acrílico

Acabamento: Dourado ou Preto (onix)



Cristais de rocha



Difusor em acrílico



● PD1713DO

● PD1713OX

Pendente

LED 30W

Lúmens: 1800lm

Temperatura: 3000K

Dimensões: C1500 x L80 x A345 mm

Tensão: Bivolt (127V/220V)

Potência máxima: 30W

Cabo ajustável até 2000 mm

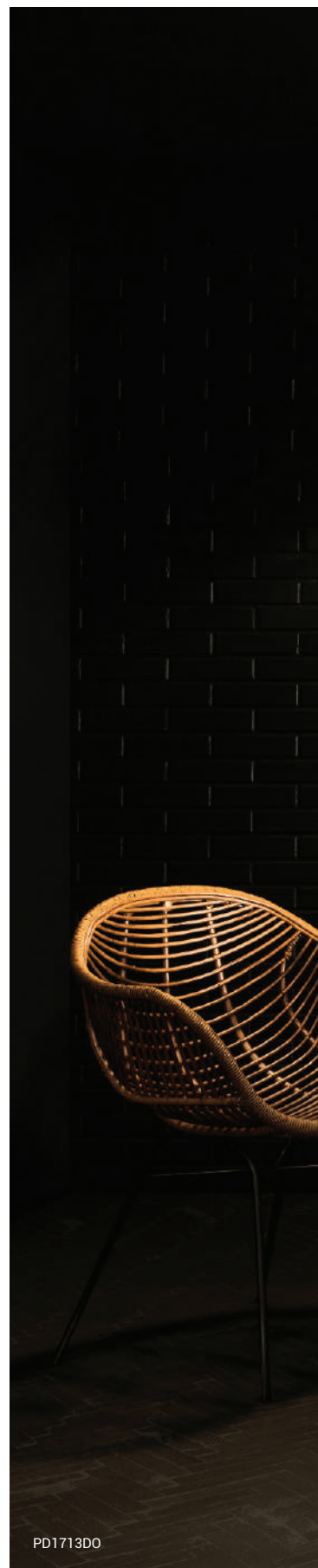

PD1713DO



Luxor

Estrutura: Metal / Cristal

Acabamento: Dourado



Detalhe do cristal



● **AR1676**
Arandela

LED 4W
Lúmens: 280lm
Temperatura: 3000K
Dimensões: C100 x L105 x A420 mm
Tensão: Bivolt (127V/220V)
Potência máxima: 4W



● **PD1677**
Pendente

LED 4W
Lúmens: 280lm
Temperatura: 3000K
Dimensões: Ø32 x A500 mm
Tensão: Bivolt (127V/220V)
Potência máxima: 4W
Cabo ajustável até 1500 mm



AR1676

Lynus

Estrutura: Metal
Difusor: Cristal transparente
Acabamento: Bronze

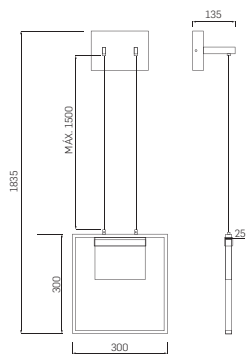
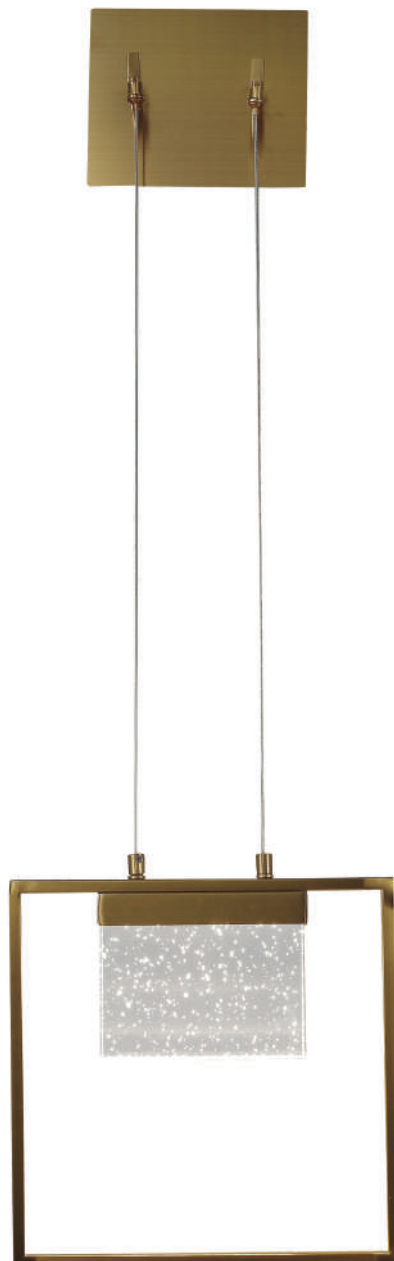

● **AR1468**
Arandela

LED 4W / 320 lm / 3000K
Dim.: C300 x L25 x A300 mm
Tensão: Bivolt (127V / 220V)
Cabo ajustável até 1500 mm

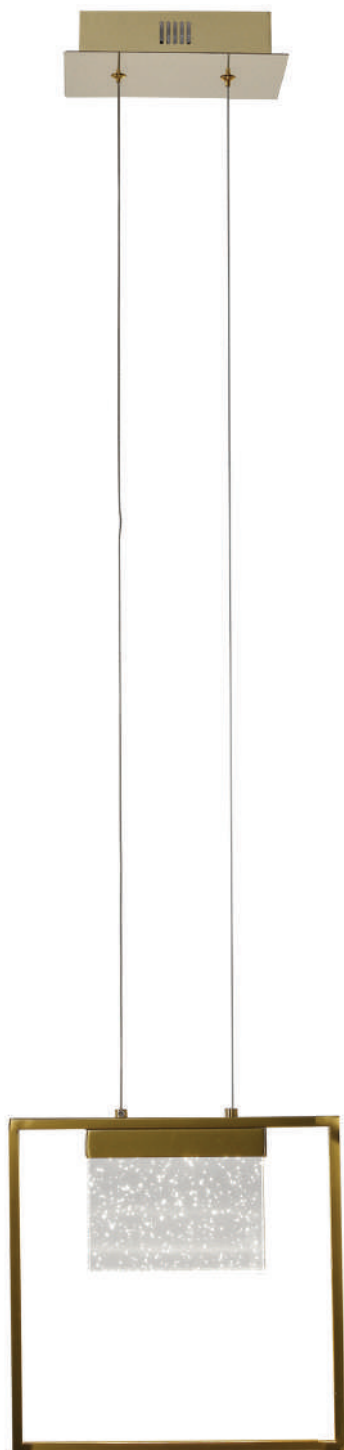

● **PD1472**
Pendente

LED 4W / 320 lm / 3000K
Dimensões: C300 xA300 mm
Tensão: Bivolt (127V / 220V)
Cabo ajustável até 1500 mm

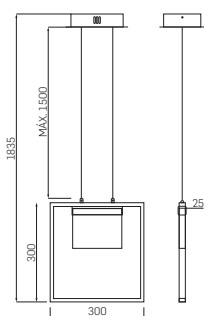

Diamond

Estrutura: Metal

Difusor: Vidro branco misto transparente

Acabamento: Dourado



● **PD1715**
Pendente

5xG9 Halopin 5W

Dimensões: C1500 x L110 x A350 mm

Tensão: Bivolt (127V/220V)

Potência máxima: 5W

Cabo ajustável até 2000 mm



● **AR1515**
Arandela

1xG9 Halopin / Máx. 5W
Dimensões: C116 x L162 x A355,5 mm
Tensão: Bivolt (127V/220V)

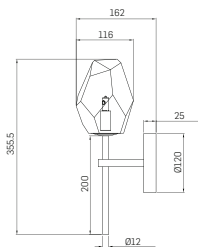

● **PD1516**
Pendente

1xG9 Halopin / Máx. 5W
Dimensões: C116 x A257,5 mm
Tensão: Bivolt (127V/220V)
Cabo ajustável até 2 m







Laticius

Estrutura: Metal

Cúpula: Vidro Craquelê ou Vidro branco

Acabamento: Dourado

Disponíveis em duas opções de difusor



Detalhe do vidro



● **AR1409**
Arandela



● **AR1409BR**
Arandela

2xG9 Halopin LED 5W
Dim.: C320 x L120 x A595 mm
Tensão: Bivolt (127V / 220V)

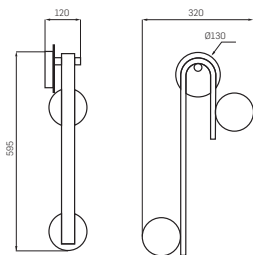



PD1407BR



● **PD1407**
Pendente



● **PD1407BR**
Pendente

3xG9 Halopin LED 5W
Dim.: C800 x L110 x A230 mm
Tensão: Bivolt (127V / 220V)
Cabo ajustável até 1500 mm

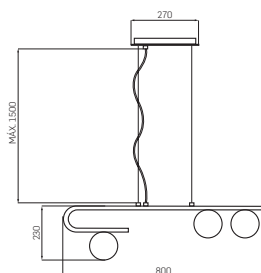

Bol

Metal e Alumínio | Acrílico | Dourado e Transparente

LANÇAMENTO • 2023



Detalhe da peça

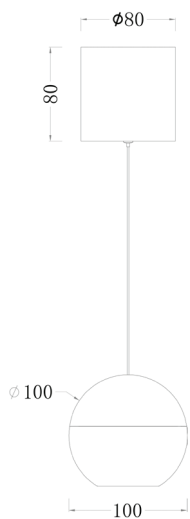

Cabo ajustável até 2000mm



● **PD1832DO**
Pendente

1XLED | 10W MAX | 570LM | 3000K
D100XA95mm
Bivolt



PD1832D0

Maya

Estrutura: Metal
 Difusor: Cristal transparente
 Acabamento: Bronze

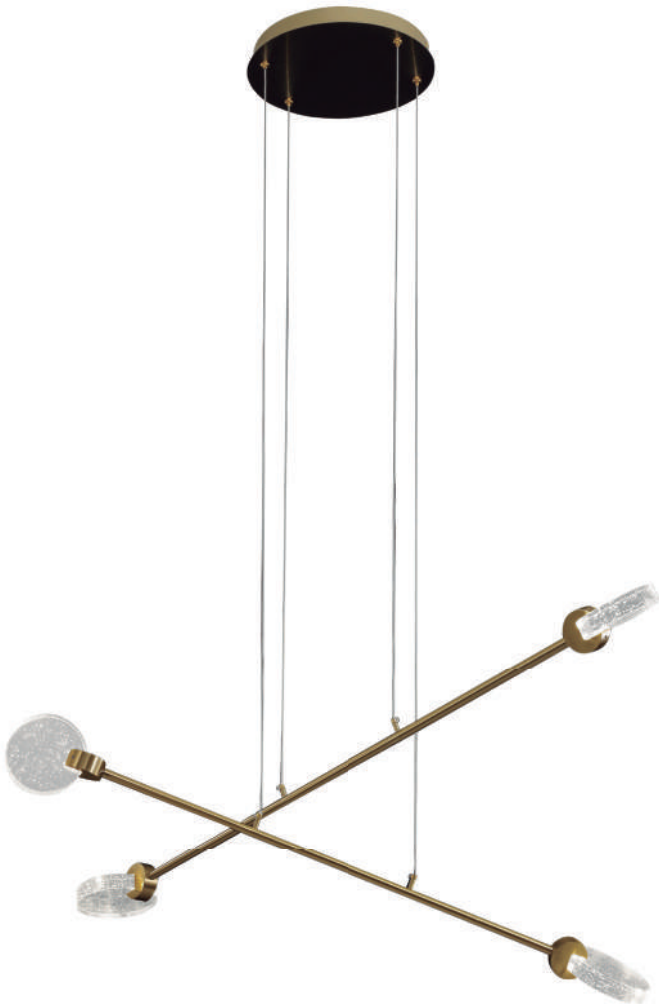

● **AR1476**
Arandela

LED 3W / 240 lm / 3000K
 Dimensões: C130 x L83 x A160 mm
 Difusor: Ø130 mm
 Tensão: Bivolt (127V / 220V)

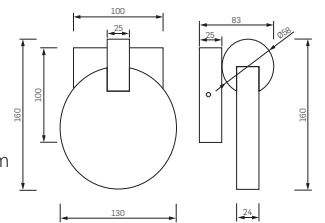

● **PD1473**
Pendente

LED 12W / 960 lm / 3000K
 Dim.: C120 x L350 x A250 mm
 Difusor: Ø110 / Ø130 mm
 Tensão: Bivolt (127V / 220V)
 Cabo ajustável até 1500 mm

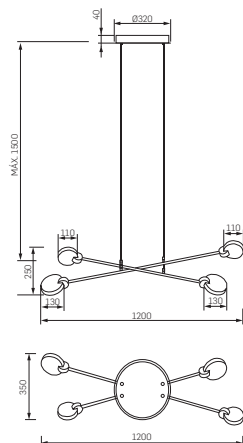



PD1475
Compatível com
canopla para gesso
(vendida separadamente)



● **PD1475**
Pendente

LED 3W / 240 lm / 3000K
Dimensões: Ø130 x A170 mm
Difusor: Ø130 mm
Tensão: Bivolt (127V / 220V)
Cabo ajustável até 1500 mm

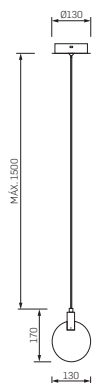

PD1475

Blur

Estrutura: Metal
 Difusor: Cristal de rocha
 Acabamento: Preto

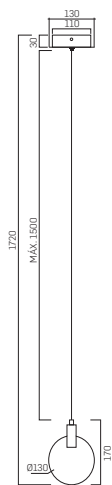

● **PD1494**
Pendente

LED 3W / 240lm / 3000K
 Dim.: Ø130 x A170 mm
 Tensão: Bivolt (127V/220V)
 Cabo ajustável até 1500 mm

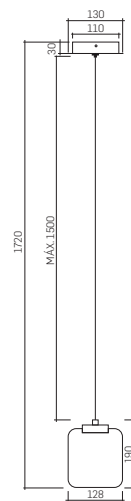

● **PD1495**
Pendente

LED 3W / 240lm / 3000K
 Dim.: C128 x A160 mm
 Tensão: Bivolt (127V/220V)
 Cabo ajustável até 1500 mm

Horus

Estrutura: Metal / Cristal
Acabamento: Dourado



● **PD1661**
Pendente

LED 3W
Lúmens: 120lm
Temperatura: 3000K
Dimensões: Ø105 x C1500 x A118 mm
Tensão: Bivolt (127V/220V)
Potência máxima: 3W
Cabo ajustável até 1500 mm



AR1660



● **AR1660**
Arandela

LED 3W
Lúmens: 120lm
Temperatura: 3000K
Dimensões: Ø105 x A118 mm
Tensão: Bivolt (127V/220V)
Potência máxima: 3W

Gali

Estrutura: Metal / Alumínio/ Acrílico
Acabamento: Dourado ou Preto (Onix)

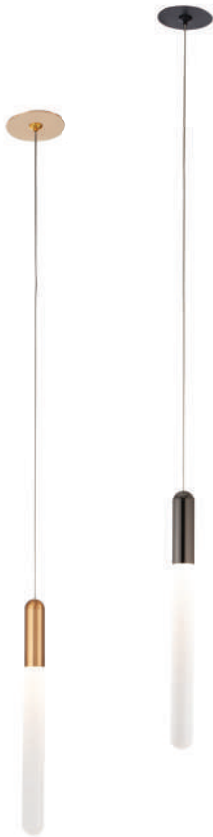

● **PD1723DO**
Pendente

LED 5W
Lúmens: 300lm
Temperatura: 3000K
Dimensões: Ø30 x L30 x A345 mm
Tensão: Bivolt (127V/220V)
Potência máxima: 5W
Cabo 2000 mm



PD17230X

PD1723DO



● **PD1724OX**
Pendente

LED 13W
Lúmens: 780lm
Temperatura: 3000K
Dimensões: Ø150 x L150 x A345 mm
Tensão: Bivolt (127V/220V)
Potência máxima: 13W
Cabo 2000 mm



PD17240X

PD1724DO



PD17240X



Hazel

Estrutura: Metal/cristal
Acabamento: Dourado

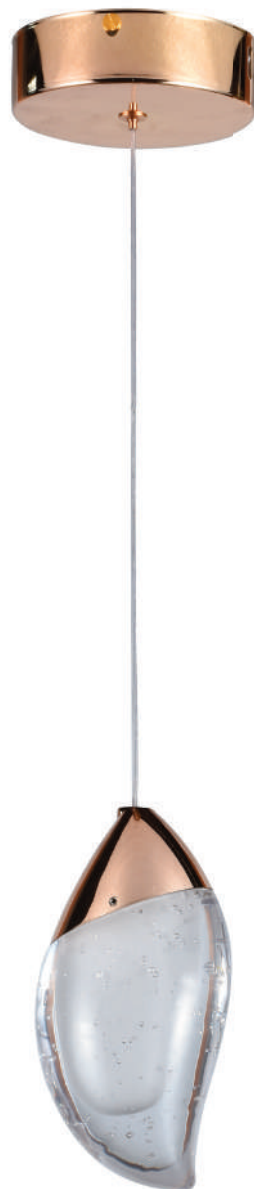

● **PD1699**
Pendente

LED 4W
Lúmens: 294lm
Temperatura: 3000K
Dimensões: Ø90 x A175 mm
Tensão: Bivolt (127V/220V)
Potência máxima: 4W
Cabo 1500 mm



PD1699

Jadore

Estrutura: Metal / Cristal
Difusor: Cristal de rocha
Acabamento: Preto ou dourado



Detalhe do difusor



● **PD16880X**
Pendente

LED 4W
Lúmens: 280lm
Temperatura: 3000K
Dimensões: Ø100 x A800 mm
Tensão: Bivolt (127V/220V)
Potência máxima: 4W
Cabo ajustável até 1500 mm



PD1688DO



PD16880X



PD16880X

Sion

Estrutura: Metal/cúpula de vidro

Vidro: Transparente

Acabamento: Preto ou Dourado

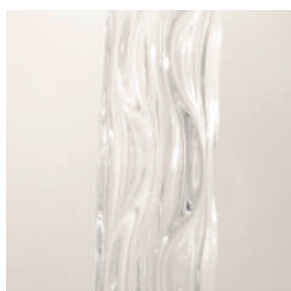

Detalhe do vidro



● **ARH1585PT**

Arandela

1xG9 Halopin 5W
Dimensões: C120 x L45 x A120 mm
Tensão: Bivolt (127V/220V)
Potência máxima: 5W

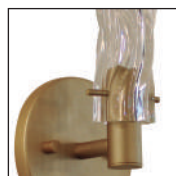

ARH1585DO



ARH1585PT



● **PDH1586DO**

Pendente

1xG9 Halopin 5W
Dimensões: Ø45 x A400 mm
Tensão: Bivolt (127V/220V)
Potência máxima: 5W
Cabo ajustável até 1500 mm



PDH1586DO



PDH1586PT



PDH1586PT

Nó

Metal | Cristal | Dourado e Transparente Fosco

LANÇAMENTO • 2023



Detalhe da peça

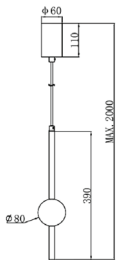

Cabo ajustável até 2000mm



● **PD1637**
Pendente

1XLED | 4W | 300LM | 3000K
D80XA390mm
Bivolt

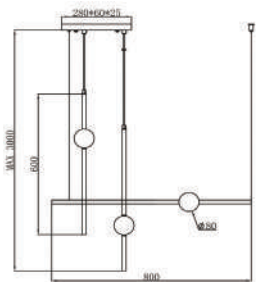

Cabo ajustável até 3000mm



● **PD1819**
Pendente

3XLED | 12W | 900LM | 2700K
C800XL80XA600mm
Bivolt

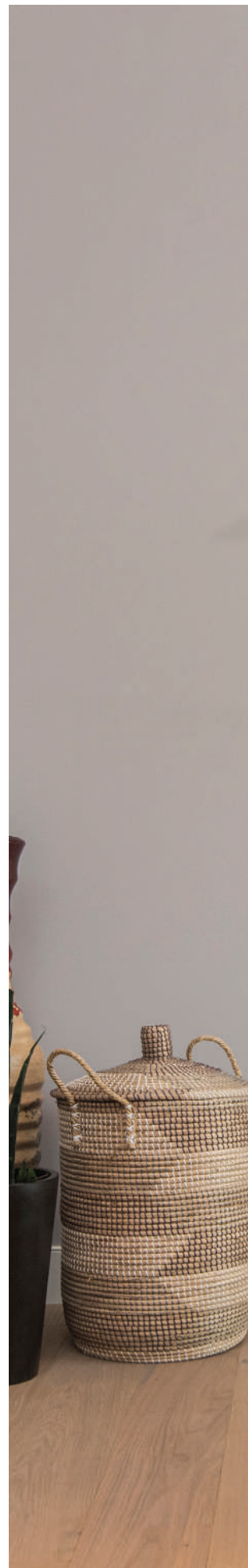



PD1819

Antik

Estrutura: Metal/ Vidro

Difusor: Vidro fosco

Acabamento: Dourado



● **AR1717DO**
Arandela

1x G9 Halopin 5W
Dimensões: L100 x P230 x A280 mm
Tensão: Bivolt (127V/220V)
Potência máxima: 5W



● **AR1718DO**
Arandela

2x G9 Halopin 5W
Dimensões: L230 x P260 x A280 mm
Tensão: Bivolt (127V/220V)
Potência máxima: 10W



PD1718DO



● **PD1716DO**
Pendente

8x G9 Halopin 5W
Dimensões: 790 x L340 x A340 mm
Tensão: Bivolt (127V/220V)
Potência máxima: 40W
Cabo ajustável até 2000 mm

Sophi

Estrutura: Metal e vidro
 Bobeche: Vidro
 Acabamento: Bronze e preto

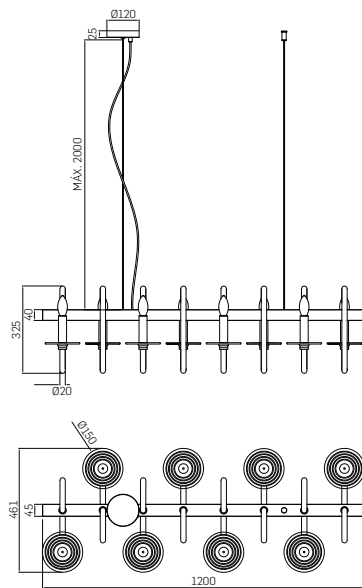
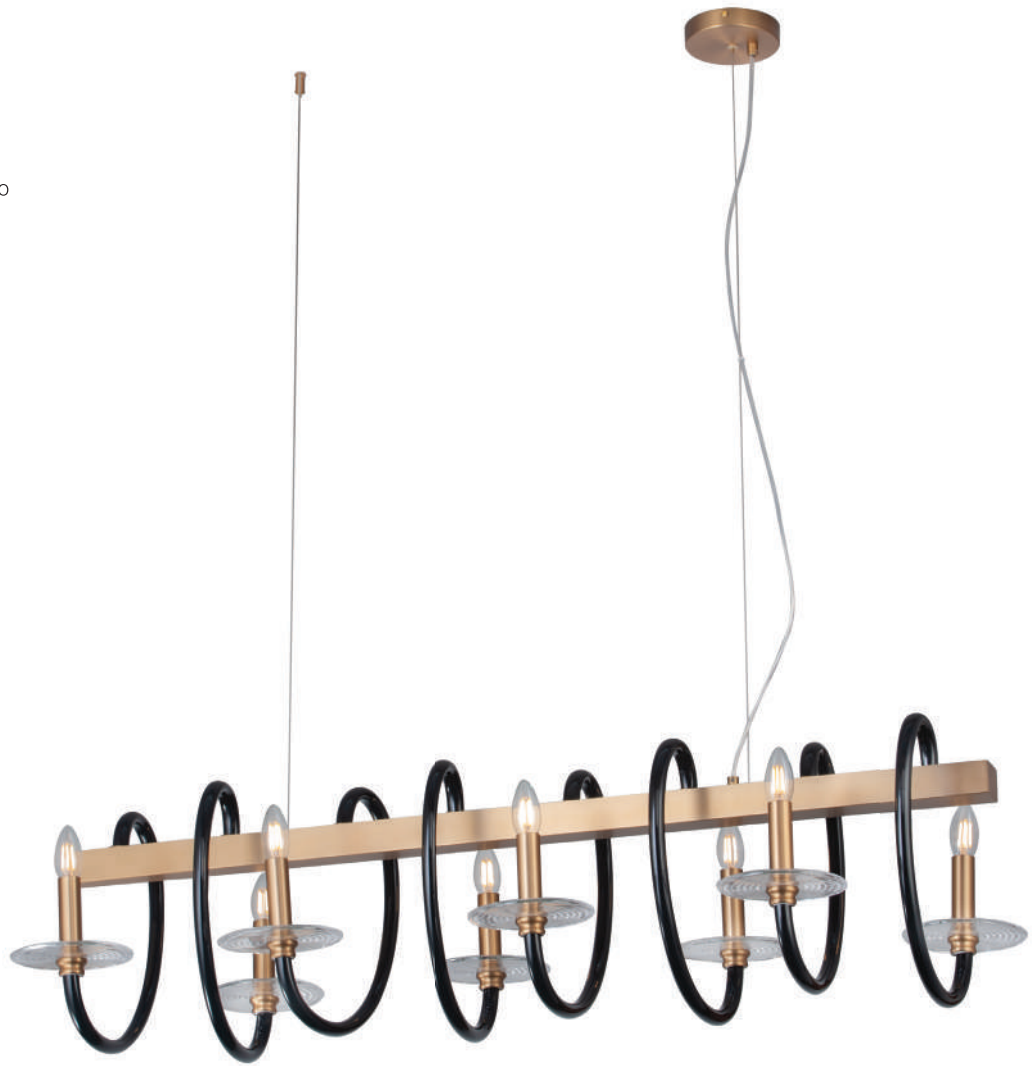

● **PD1512**
Pendente

8xE14 / 40W
 Dimensões: C1200 x L461 x A325 mm
 Tensão: Bivolt (127V/220V)
 Cabo ajustável até 2000 mm



AR1511



● **AR1511**
Arandela

1xE14 / 40W
Dimensões: C357 x L120 x A321 mm
Tensão: Bivolt (127V/220V)

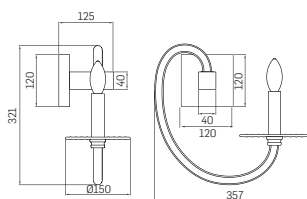

Suez

Estrutura: Alumínio

Difusor: Material tipo alabastro

Acabamento: Dourado ou preto



● ARSH1568DO

● ARSH1568PT

Arandela/Plafon

LED 8,4W / 167,4lm / 3000K
 Potência Máx.: 8,4W
 Dimensões: C145 x L80 x A300 mm
 Tensão: Bivolt (127V/220V)

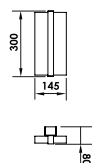

● ARSH1569DO

● ARSH1569PT

Arandela/Plafon

LED 21W / 418,5lm / 3000K
 Potência máx.: 21W
 Dimensões: C145 x L80 x A550 mm
 Tensão: Bivolt (127V/220V)

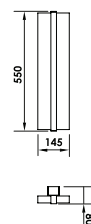



● ARSH1570DO

● ARSH1570PT

Arandela/Plafon

LED 33,6W / 669,6lm / 3000K

Potência máx.: 33,6W

Dimensões: C145 x L80 x A800 mm

Tensão: Bivolt (127V/220V)

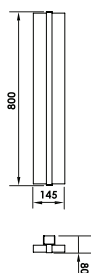

Suez

Estrutura: Alumínio
 Difusor: Material tipo alabastro
 Acabamento: Dourado ou preto



LMSH1574DO



- LMSH1574DO
- LMSH1574PT

Luminária de mesa

LED 21W / 418,5lm / 3000K
 Potência máx.: 21W
 Dimensões: C160 x L110 x A640 mm
 Tensão: Bivolt (127V/220V)

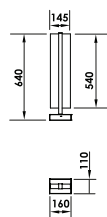

- CLSH1575DO
- CLSH1575PT

Coluna

LED 21W / 418,5lm / 3000K
 Potência máx.: 21W
 Dimensões: C160 x L160 x A1390 mm
 Tensão: Bivolt (127V/220V)

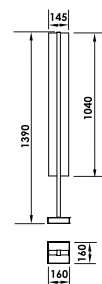



CLSH1575PT

Suez

Estrutura: Alumínio

Difusor: Material tipo alabastro

Acabamento: Dourado ou preto



- PDSH1566LED1DO (127V)
- PDSH1566LED2DO (220V)
- PDSH1566LED1PT (127V)
- PDSH1566LED2PT (220V)

Pendente

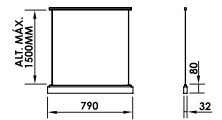

LED 13,2W / 270lm / 3000K
 Potência máx.: 13,2W
 Dimensões: C790 x L80 x A32 mm
 Tensão: 127V ou 220V

- PDSH1567LED1DO (127V)
- PDSH1567LED2DO (220V)
- PDSH1567LED1PT (127V)
- PDSH1567LED2PT (220V)

Pendente

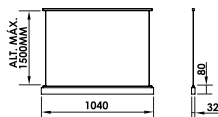

LED 17,6W / 360lm / 3000K
 Potência máx.: 17,6W
 Dimensões: C1040 x L80 x A32 mm
 Tensão: 127V ou 220V



PDSH1567LED1PT

Suez

Estrutura: Alumínio

Difusor: Material tipo alabastro

Acabamento: Dourado ou preto



- PLSH1561LED1DO (127V)
- PLSH1561LED2DO (220V)
- PLSH1561LED1PT (127V)
- PLSH1561LED2PT (220V)

Arandela/Plafon

LED 4,4W / 90lm / 3000K
 Potência máx.: 4,4W
 Dimensões: C290 x L80 x A32 mm
 Tensão: 127V ou 220V

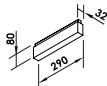

- PLSH1562LED1DO (127V)
- PLSH1562LED2DO (220V)
- PLSH1562LED1PT (127V)
- PLSH1562LED2PT (220V)

Arandela/Plafon

LED 8,8W / 180lm / 3000K
 Potência máx.: 8,8W
 Dimensões: C540 x L80 x A32 mm
 Tensão: 127V ou 220V

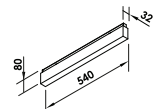



PLSH1563LED1PT



- PLSH1563LED1DO (127V)
- PLSH1563LED2DO (220V)
- PLSH1563LED1PT (127V)
- PLSH1563LED2PT (220V)

Arandela/Plafon

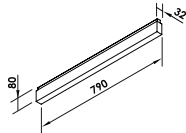

LED 13,2W / 270lm / 3000K
 Potência máx.: 13,2W
 Dimensões: C790 x L80 x A32 mm
 Tensão: 127V ou 220V



- PLSH1564LED1DO (127V)
- PLSH1564LED2DO (220V)
- PLSH1564LED1PT (127V)
- PLSH1564LED2PT (220V)

Arandela/Plafon

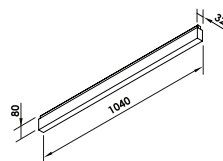

LED 17,6W / 360lm / 3000K
 Potência máx.: 17,6W
 Dimensões: C1040 x L80 x A32 mm
 Tensão: 127V ou 220V

Suez

Estrutura: Alumínio

Difusor: Material tipo alabastro

Acabamento: Dourado ou preto



● PLSH1589DO

● PLSH1589PT

Arandela/Plafon

LED 26,6W / 630lm / 3000K

Potência máx.: 26,6W

Dimensões: C540 x L540 x A40 mm

Tensão: 127V / 220V

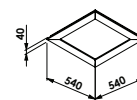

● PLSH1588DO

● PLSH1588PT

Arandela/Plafon

LED 19W / 450lm / 3000K

Potência máx.: 19W

Dimensões: C400 x L400 x A40 mm

Tensão: 127V / 220V

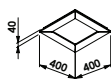



PLSH1589D0

Suez

Estrutura: Alumínio

Difusor: Material tipo alabastro

Acabamento: Dourado ou preto



- PDSH1572DO
- PDSH1572PT

Pendente

LED 8,4W / 167,4lm / 3000K
 Potência máx.: 8,4W
 Dimensões: C145 x L40 x A300 mm
 Tensão: Bivolt (127V/220V)

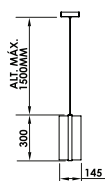

- PDSH1573DO
- PDSH1573PT

Pendente

LED 21W / 418,5lm / 3000K
 Potência máx.: 21W
 Dimensões: C145 x L40 x A550 mm
 Tensão: Bivolt (127V/220V)

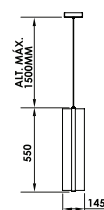



PDSH1573PT

Suez

Estrutura: Alumínio

Difusor: Material tipo alabastro

Acabamento: Dourado ou preto



● PDSH1575DO

● PDSH1575PT

Pendente

LED 42W / 837lm / 3000K

Potência máx.: 42W

Dimensões: C1050 x L145 x A40 mm

Tensão: Bivolt (127V/220V)

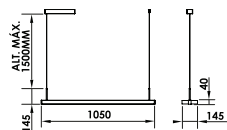



PDSH1575D0

Frida

_DESIGN
STUDIOLUCE

Metal | Alabastro | Dourado e Branco



Detalhe da peça



● **AR1824**
Arandela

1XG9 | 5W MAX
C100XL115XA170mm
Bivolt

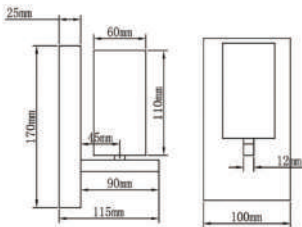

● **PD1825**
Pendente

1XG9 | 5W MAX
D60XA223mm
Bivolt

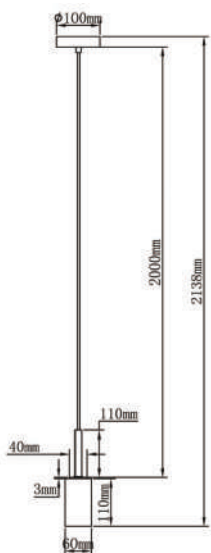

Cabo ajustável até 2000mm





PD1825

Frida

_DESIGN
STUDIOLUCE

Metal | Alabastro | Dourado e Branco

LANÇAMENTO • 2023



Detalhe da peça

POSSÍVEL INSTALAR
DE DUAS FORMAS

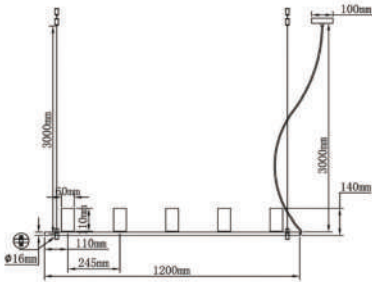

Cabo ajustável até 3000mm



● **PD1826**

Pendente

5XG9 | 25W MAX |
C1220XL60XA140mm
Bivolt

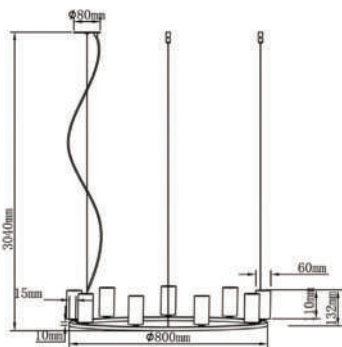

Cabo ajustável até 3000mm



● **PD1827**

Pendente

9XG9 | 45W MAX | C10cm
D800XA132mm
Bivolt



PD1827

Cora

_DESIGN
STUDIOLUCE

Metal | Alabastro | Dourado e Branco

LANÇAMENTO • 2023

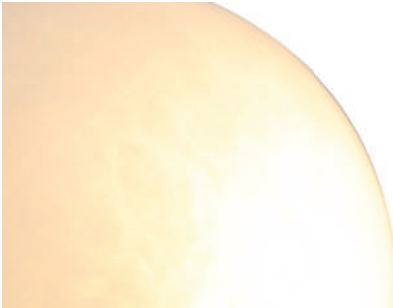

Detalhe da peça

INSTALAÇÃO DE EMBUTIR

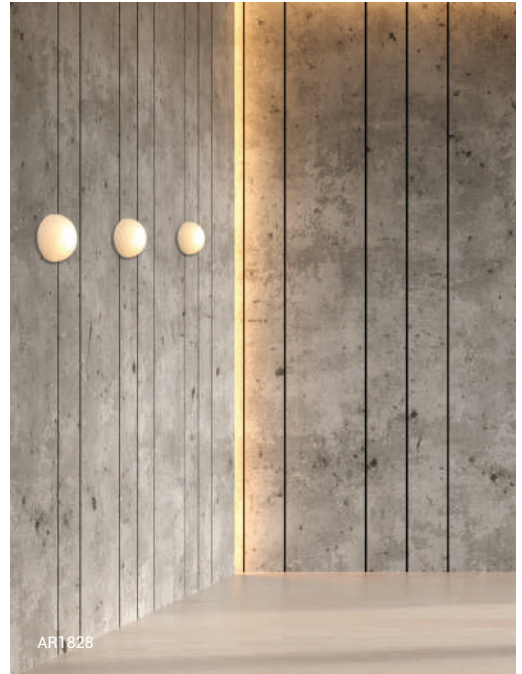

AR1828

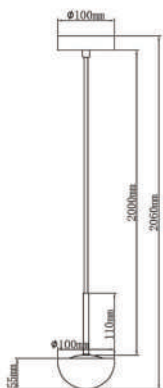
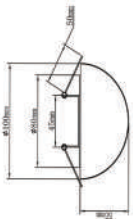

Cabo ajustável até 2000mm

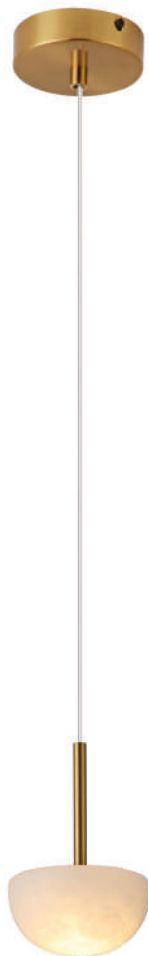

● PD1829
Pendente

1XLED | 3W | 210LM | 2700K
D100XA165mm
Bivolt



● AR1828
Arandela

1XLED | 3W | 210LM | 2700K
D100XA65mm
Bivolt



● **PD1830**
Pendente

7XLED | 21W | 1470LM | 2700K
C1200XL100XA360mm
Bivolt

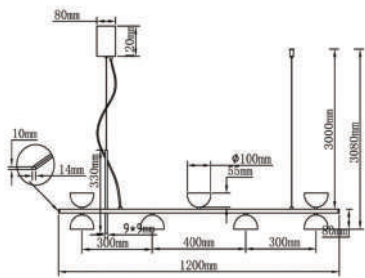

Cabo ajustável até 3000mm



Versa

Estrutura: Aço inox

Difusor: Sílica gel branco

Acabamento: Dourado ou Preto (onix)



● PD1708DO

● PD1708OX

Pendente

LED 91W

Lúmens: 6370lm

Temperatura: 2900K

Dimensões: C1550 x L330 x A360 mm

Tensão: Bivolt (127V/220V)

Potência máxima: 91W

Cabo ajustável até 1500 mm



PD17080X

Atenas

Estrutura: Metal/ Acrílico

Difusor: Acrílico

Acabamento: Dourado

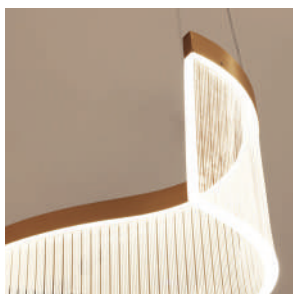

● **PD1764**
Pendente

LED 28W
Lúmens: 1468lm
Temperatura: 3000K
Dimensões: C1000 x L295 x A150 mm
Tensão: Bivolt (127V/220V)
Potência máxima: 28W
Cabo ajustável até 3000 mm



● **PD1765**
Pendente

LED 37W
Lúmens: 1762lm
Temperatura: 3000K
Dimensões: C1500 x L435 x A150 mm
Tensão: Bivolt (127V/220V)
Potência máxima: 37W
Cabo ajustável até 3000 mm



PD1765

Véu

_DESIGN
STUDIOLUCE

Metal | Acrílico | Dourado e Transparente

LANÇAMENTO • 2023

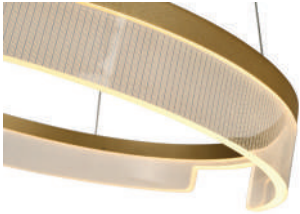

Detalhe da peça

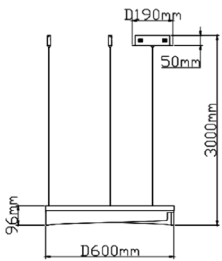

Cabo ajustável até 3000mm



● PD1790
Pendente

1XLED | 42W | 2100LM | 3000K
D600XA96mm
Bivolt

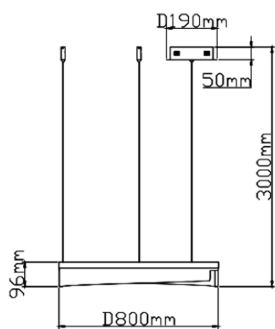

Cabo ajustável até 3000mm



● PD1791
Pendente

1XLED | 50W | 2500LM | 3000K
D800XA96mm
Bivolt

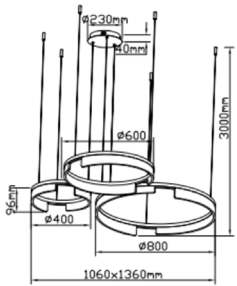

Cabo ajustável até 3000mm



● **PD1789**
Pendente

1XLED | 89W | 4450LM | 3000K
D800 + D600 + D400 x A96mm
Bivoit



PD1789

Namastê

Metal | Acrílico | Dourado e Transparente

LANÇAMENTO • 2023



Detalhe da peça

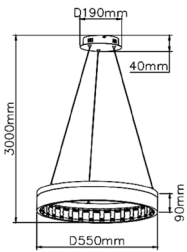

Cabo ajustável até 3000mm



● **PD1792**
Pendente

1XLED | 30W | 1500LM | 3000K
D550XA90mm
Bivolt

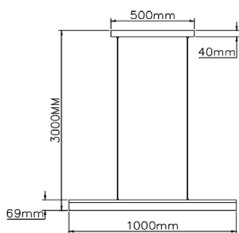

Cabo ajustável até 3000mm

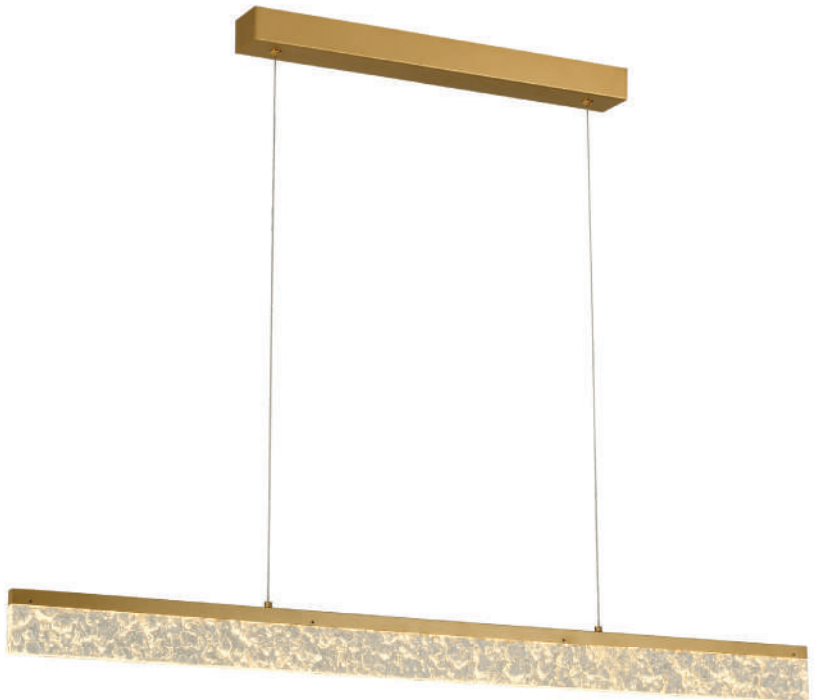

● **PD1793**
Pendente

1XLED | 30W | 1500LM | 3000K
C1000XL15XA69mm
Bivolt



PD1793

Alma

_DESIGN
STUDIOLUCE

Metal | Acrílico | Dourado e Transparente

LANÇAMENTO • 2023



Detalhe da peça

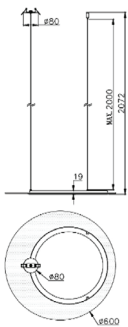

Cabo ajustável até 2000mm



● **PD1809**
Pendente

1XLED | 38W | 3100LM | 3000K
D600XA19mm
Bivolt

*com canopla para gesso

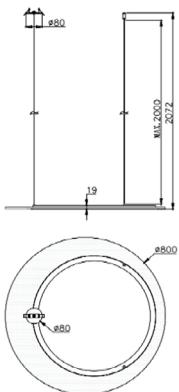

Cabo ajustável até 2000mm



● **PD1810**
Pendente

1XLED | 61W | 4900LM | 3000K
D800XA19mm
Bivolt

*com canopla para gesso

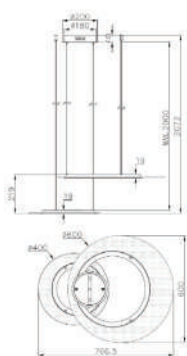

Cabo ajustável até 2000mm

● **PD1811**
Pendente

2XLED | 58W | 4550LM | 3000K
D600 + D400 x A19mm
Bivolt

*canopla para alvenaria



PD1811

Traço

_DESIGN
STUDIOLUCE

Metal | Acrílico | Dourado e Transparente

LANÇAMENTO • 2023



Detalhe da peça

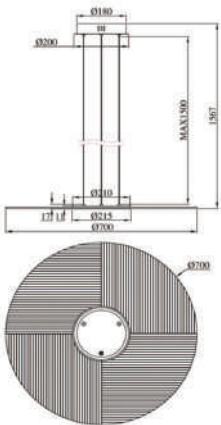

Cabo ajustável até 1500mm



● **PD1868**

Pendente

1XLED | 18W | 1650LM | 3000K
D700XA11mm
Bivolt



● **AR1869**

Arandela

1XLED | 6W | 530LM | 3000K
D250XA51mm
Bivolt

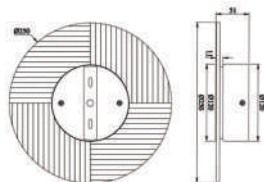



PD1868

Tomie

_DESIGN
STUDIOLUCE

Metal | Acrílico | Dourado ou Grafite

LANÇAMENTO • 2023

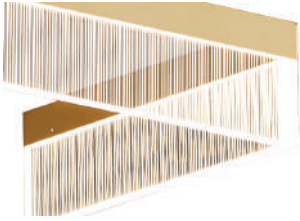

Detalhe da peça

PRODUTOS INSTALADOS INDIVIDUALMENTE.
POSSIBILITA DIFERENTES COMPOSIÇÕES.

Canoplas são para gesso ou de embutir.
Drivers ficam alojados no forro.



● **PD1808**
Pendente

LED | 18,5W + 18,5W | 2015LM | 3000K
C970XL280XA73mm
Bivolt

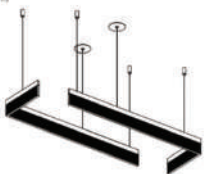
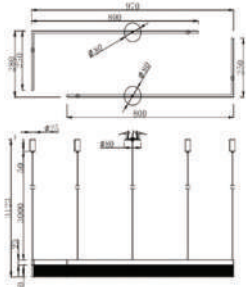

Cabo ajustável até 3000mm

● **PD1808GR**
Pendente

LED | 18,5W + 18,5W | 2015LM | 3000K
C970XL280XA73mm
Bivolt

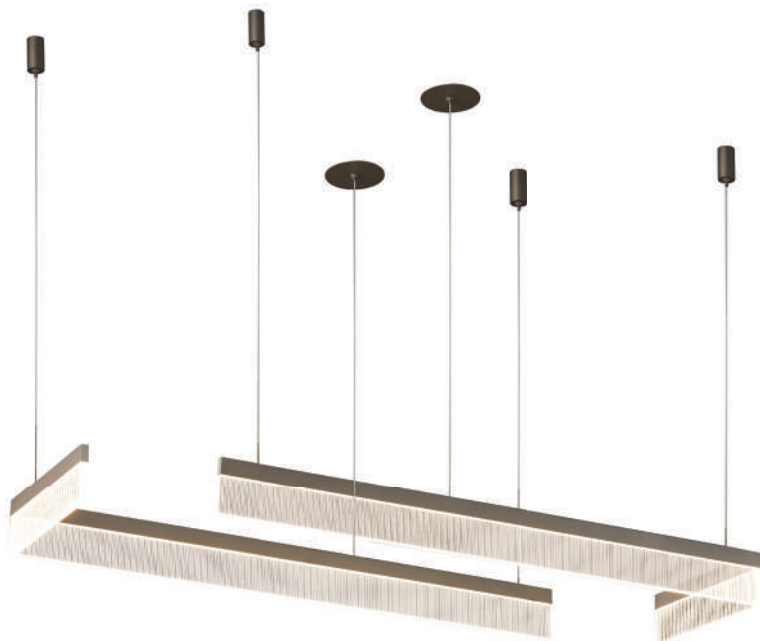



PD1808

Candela

_DESIGN
STUDIOLUCE

Metal | Acrílico | Grafite e Transparente



Canopla para gesso com driver alojado no forro.

Detalhe da peça



● **PD1859**

Pendente

1XLED | 49W MAX | 4400LM | 3000K
D700XA65mm
Bivolt

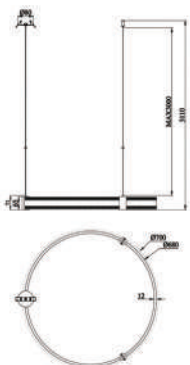

Cabo ajustável até 3000mm



PD1859

Lina

Metal | Acrílico | Dourado e Transparente



Detalhe da peça



● **PD1795**
Pendente

1XLED | 24W | 1920LM | 3000K
C1185XL20XA67mm
Bivolt

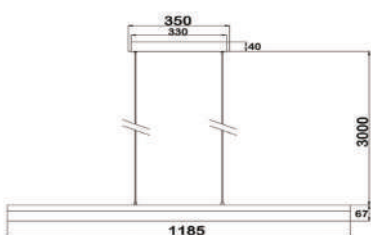

Cabo ajustável até 3000mm



Lune

Estrutura: Metal

Difusor: Vidro canelado transparente e parte interna em vidro opalino

Acabamento: Dourado

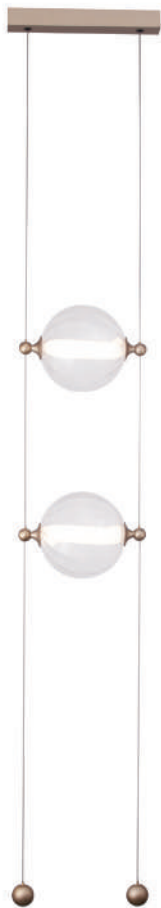

● **PD1519**
Pendente

12V / 2x11W / 1320lm / 3000K
Dimensões: Ø200 x C350 x A2098 mm
Tensão: Bivolt (127V/220V)
Cabo ajustável até 2100 mm

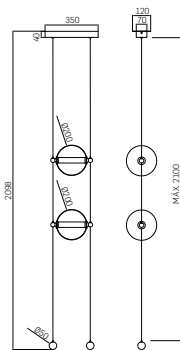

● **PD1518**
Pendente

12V / 11W / 660 lm / 3000K
Dimensões: Ø200 x C350 x A2098 mm
Tensão: Bivolt (127V/220V)
Cabo ajustável até 2100 mm

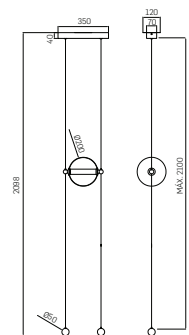

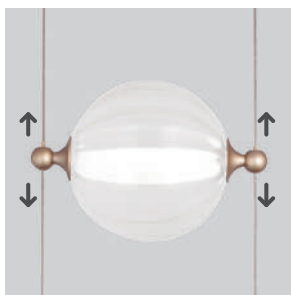

Difusor com posição ajustável através de trava-cabo de fácil manuseio



● **PD1520**
Pendente

12V / 4x10W / 2400lm / 3000K
 Dimensões: Ø200 x C1100 x A2098 mm
 Tensão: Bivolt (127V/220V)
 Cabo ajustável até 2100 mm

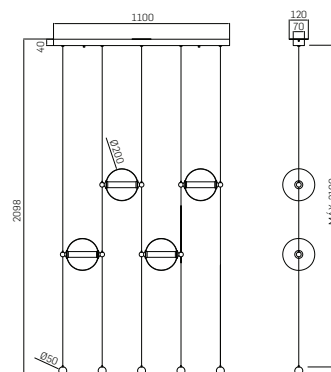

Lance

Estrutura: Metal/ Silicone

Difusor: Silica gel

Acabamento: Preto



Difusor
em material
flexível
- Sílica gel -

● **PD1739**

Pendente

LED 40W

Lúmens: 2800lm

Potência: 3000K

Dimensões: C2000 x A600 mm

Tensão: Bivolt (127V/220V)

Potência máxima: 40W



PD1739

Lorum

Estrutura: Metal/ Vidro / Couro sintético

Difusor: Acrílico

Acabamento: Preto



● **PD1738**
Pendente

LED 13W + 15w

Lúmens: 1960lm

Potência: 3000K

Dimensões: C470+450 x A1300 + 1500 mm

Tensão: Bivolt (127V/220V)

Potência máxima: 28W



PD1738

Zavo

Estrutura: Metal

Difusor **CL1493**: Acrílico (rígido)

Acabamento: Preto ou dourado

Difusor
em material
rígido
- Acrílico -

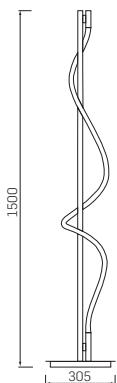

Possui cabo com
interruptor liga e desliga
para ser ligado a tomada



● **CL1493**
Coluna

LED 15W / 720lm / 3000K
Dim.: Ø305 x A1500 mm
Tensão: Bivolt (127V/220V)



CL1493

Dock

Estrutura: Metal/Sílica gel
Difusor: Tubo em sílica gel opalino
Acabamento: Dourado

Difusor
em material
flexível
- Sílica gel -



● **PD1746**
Pendente

LED 10W
Lúmens: 700lm
Temperatura: 3000K
Dimensões: C840 x L22 x A620 mm
Tensão: Bivolt (127V/220V)
Potência máxima: 10W



● **PD1747**
Pendente

LED 15W
Lúmens: 1050lm
Temperatura: 3000K
Dimensões: C1100 x L22 x A800 mm
Tensão: Bivolt (127V/220V)
Potência máxima: 15W



PD1746 / PD1747

Lamar

Metal | Acrílico | Preto e Dourado

LANÇAMENTO • 2023



● **PL1665**
Plafon

1XLED | 58W | 4060LM | 3000K
C1385XL1160XA1060mm
Bivolt

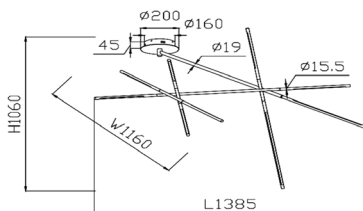



PL1665

Wala

Estrutura: Metal/ Acrílico

Acabamento: Dourado ou Preto (onix)



● **PD1686DO**

Pendente

LED 12W

Lúmens: 960lm

Temperatura: 3000K

Dimensões: C140 x L22 x A650 mm

Tensão: Bivolt (127V/220V)

Potência máxima: 12W

Cabo ajustável até 1500 mm



PD1686DO

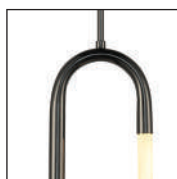

PD1686OX



● **AB1685DO**

Abajur

LED 12W
Lúmens: 960lm
Temperatura: 3000K
Dimensões: Ø150 x A525 mm
Tensão: Bivolt (127V/220V)
Potência máxima: 12W



AB1685DO



AB1685OX

Wala

Estrutura: Metal/ Acrílico

Acabamento: Dourado ou Preto (onix)

● **CL1687DO**

Coluna

LED 18W

Lúmens: 1440lm

Temperatura: 3000K

Dimensões: Ø200 x A1200 mm

Tensão: Bivolt (127V/220V)

Potência máxima: 18W

Possui cabo com interruptor liga e desliga para ser ligado a tomada



CL1687DO



CL1687OX





CL16870X

Anello

Estrutura: Metal/alumínio/acrílico

Acrílico: Transparente

Acabamento: Dourado

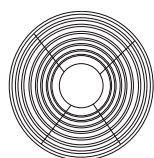
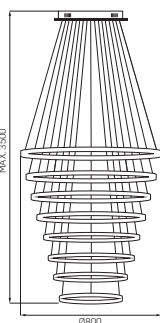

● **PD1442**
Pendente

LED 180W / 9000lm / 3000K
Dimensões:
Ø800 + Ø730 + Ø670 + Ø605 +
Ø540 + Ø480 + Ø415 + Ø350 x
A3500 mm
Tensão: Bivolt (127V/220V)
Cabo ajustável até 3500 mm



PD1442

Anello

Estrutura: Metal/alumínio/acrílico

Acrílico: Transparente

Acabamento: Dourado

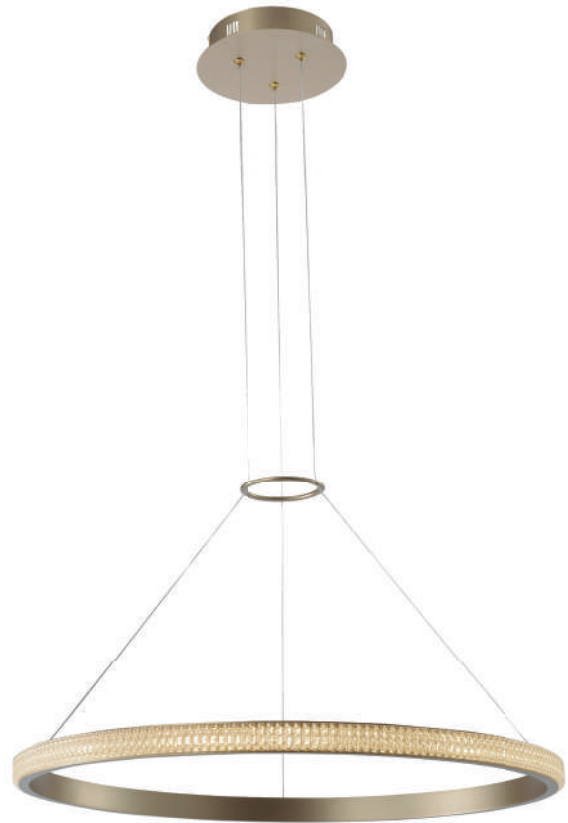

● **PD1440**
Pendente

LED 28W / 1400lm / 3000K
Dimensões: Ø605 x A1200 mm
Tensão: Bivolt (127V/220V)
Cabo ajustável até 1500 mm

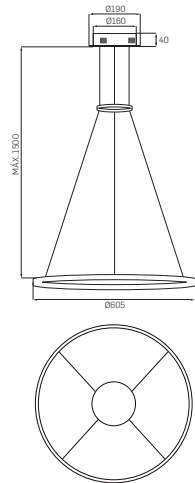

● **PD1441**
Pendente

LED 40W / 2000lm / 3000K
Dim.: Ø670 + Ø480 x A1500 mm
Tensão: Bivolt (127V/220V)
Cabo ajustável até 1500 mm

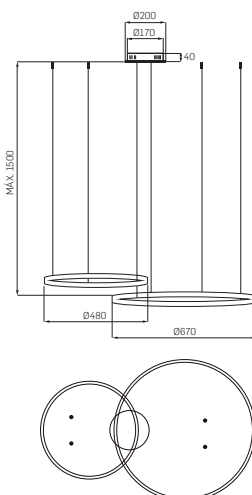
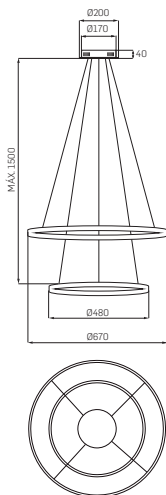

CAN008
Canopla

Opção de instalação com apenas canopla, sem chumbadores

Vendido separadamente



PD1440



● **AR1487**
Arandela

LED 7W / 350lm / 3000K
Dimensões: C350 x A30 mm
Tensão: Bivolt (127V/220V)

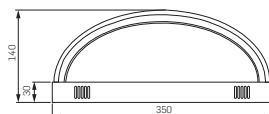

Anello Oval

Estrutura: Metal/alumínio/acrílico

Acrílico: Transparente

Acabamento: Dourado



● **PD1443**
Pendente

LED 28W / 1400lm / 3000K
Dimensões: Ø800 x A30 mm
Tensão: Bivolt (127V/220V)
Cabo ajustável até 1500 mm

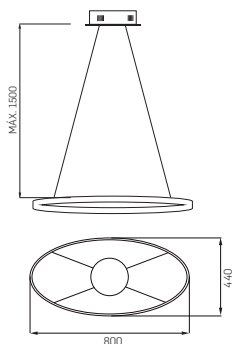



Balka

Estrutura: Metal / Vidro

Difusor: Vidro fosco

Acabamento: Branco ou Dourado



● PD1712BR

● PD1712DO

Pendente

40x G9 Halopin LED 5W

Dimensões: Ø1000 x A480 mm

Tensão: Bivolt (127V/220V)

Potência máxima: 200W

Cabo ajustável até 1500 mm



PDT1712D0

Cissy

Estrutura: Metal

Difusor: Acrílico com efeito degradê
(fosco/cristal)

Acabamento: Dourado ou preto



● **PD1509**
Pendente

8L / 30W / 1800 lm / 3000K
Dimensões: Ø750 x A500 mm
Tensão: Bivolt (127V/220V)
Cabo ajustável até 2000 mm

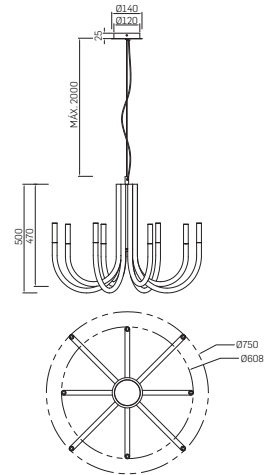

● **PD1510**
Pendente

15L / 59W / 3540lm / 3000K
Dimensões: Ø850 x A595 mm
Tensão: Bivolt (127V/220V)
Cabo ajustável até 2000 mm

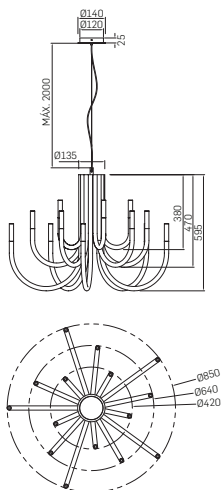

PD1510



PD1642DO



● PD1642DO

● PD1642PT

Pendente

5L / 15W / 900lm / 3000K
Dimensões: L1200 x A400 x P490 mm
Tensão: Bivolt (127V/220V)
Cabo ajustável até 2000 mm

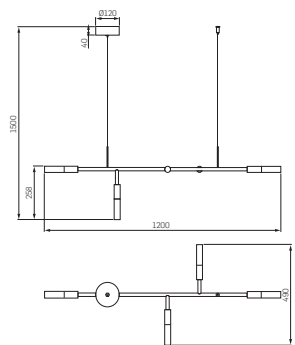

Cissy

Estrutura: Metal

Difusor: Acrílico com efeito degradê
(fosco/cristal)

Acabamento: Dourado ou preto



● PD1508DO

● PD1508PT

Pendente

3W / 180lm / 3000K
Dimensões: Ø30 x A360 mm
Tensão: Bivolt (127V/220V)
Cabo ajustável até 2000 mm

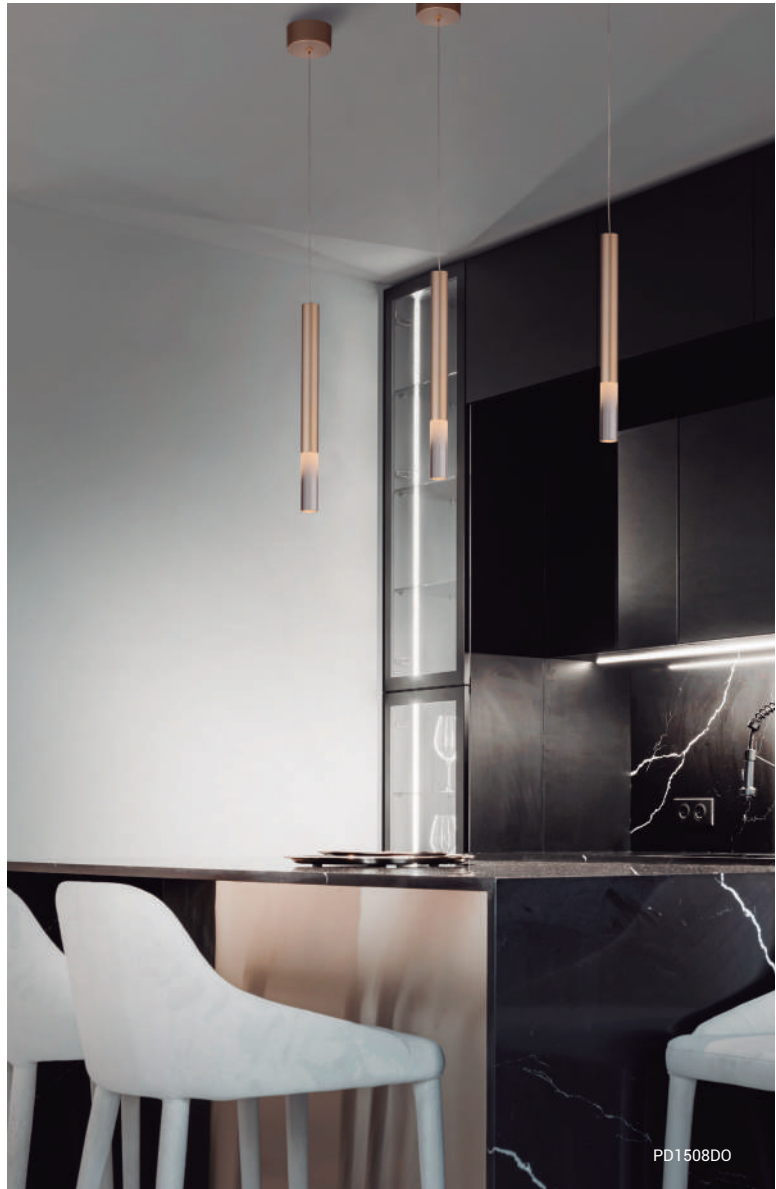

PD1508DO



PD1508DO / PD1508PT
Compatíveis com
canopla para gesso
(vendida separadamente)



● **AR1722**
Arandela

LED 3W
Lúmens: 180lm
Temperatura: 3000K
Dimensões: L120x P190 x A320 mm
Tensão: Bivolt (127V/220V)
Potência máxima: 3W



● **AR1507**
Arandela

10W / 600 lm / 3000K
Dimensões: C245 x L170 x A320 mm
Tensão: Bivolt (127V/220V)

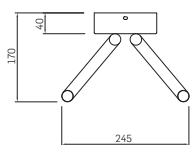
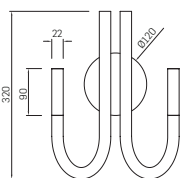

Cissy

Estrutura: Metal
Difusor: Acrílico com efeito degradê
(fosco/cristal)
Acabamento: Dourado ou preto



● PD1484DO

● PD1484PT

Pendente

3W / 180lm / 3000K
Dimensões: Ø200 x A300 mm
Tensão: Bivolt (127V/220V)
Cabo ajustável até 2000 mm



PD1484D0

Blade

Estrutura: Metal

Difusor: Acrílico com efeito degradê
(fosco/cristal)

Acabamento: Dourado ou preto



● PD1501ADO

● PD1501A

Pendente

10L / 39W / 2340lm / 3000K
Dim.: Ø700 x A370 mm
Tensão: Bivolt (127V/220V)
Cabo ajustável até 2000 mm

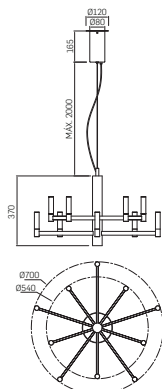



PD1502ADO



● PD1502ADO

● PD1502A

Pendente

16L / 54W / 3240lm / 3000K
Dimensões: Ø840 x A485 mm
Tensão: Bivolt (127V/220V)
Cabo ajustável até 2000 mm

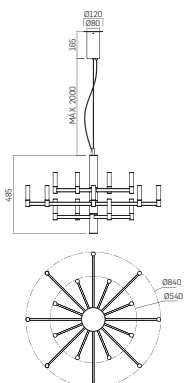

Blade

Estrutura: Metal

Difusor: Acrílico com efeito degradê
(fosco/cristal)

Acabamento: Dourado ou preto



● AR1500ADO

● AR1500A

Arandela

3W / 180lm / 3000K

Dimensões: C50 x L90 x A155 mm

Tensão: Bivolt (127V/220V)

Potência máxima: 3W

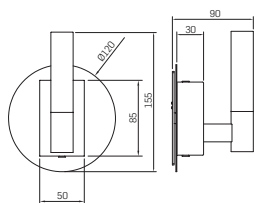



AR1500ADO

Zione

Estrutura: Metal

Difusor: Acrílico

Acabamento: Dourado ou preto



● **AR1647DO**

● **AR1647PT**

Arandela

LED 3W

Lúmens: 240lm

Temperatura: 3000K

Dimensões: L30 x P48 x A145 mm

Tensão: Bivolt (127V/220V)

Potência máxima: 3W



● **AR1646DO**

● **AR1646PT**

Arandela

LED 2x3W

Lúmens: 480lm

Temperatura: 3000K

Dimensões: L30 x P48 x A250 mm

Tensão: Bivolt (127V/220V)

Potência máxima: 6W



AR1646PT

Zione

Estrutura: Metal
 Difusor: Acrílico
 Acabamento: Dourado ou preto



Pendente articulável



PD1488DO / PD1488PT
 Compatíveis com
 canopla para gesso
 (vendida separadamente)

- **PD1488DO**
 - **PD1488PT**
- Pendente

LED 1x3W / 240 lm / 3000K
 Dim.: Ø35 x A380 mm
 Tensão: Bivolt (127V/220V)
 Cabo ajustável até 1500 mm

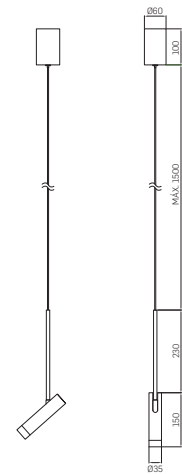

- **PD1491DO**
 - **PD1491**
- Pendente

LED 6x3W / 1440 lm / 3000K
 Dim.: C1100 x A145 mm
 Tensão: Bivolt (127V/220V)
 Cabo ajustável até 1500 mm

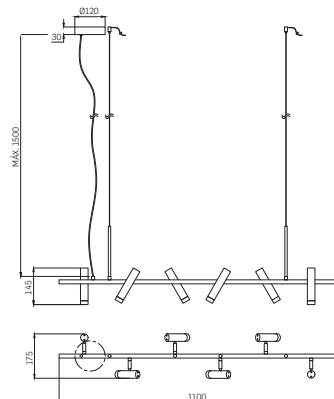

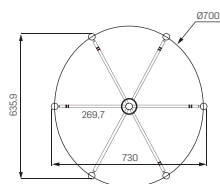
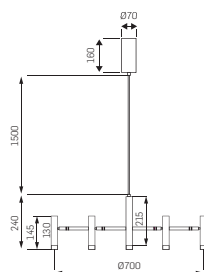
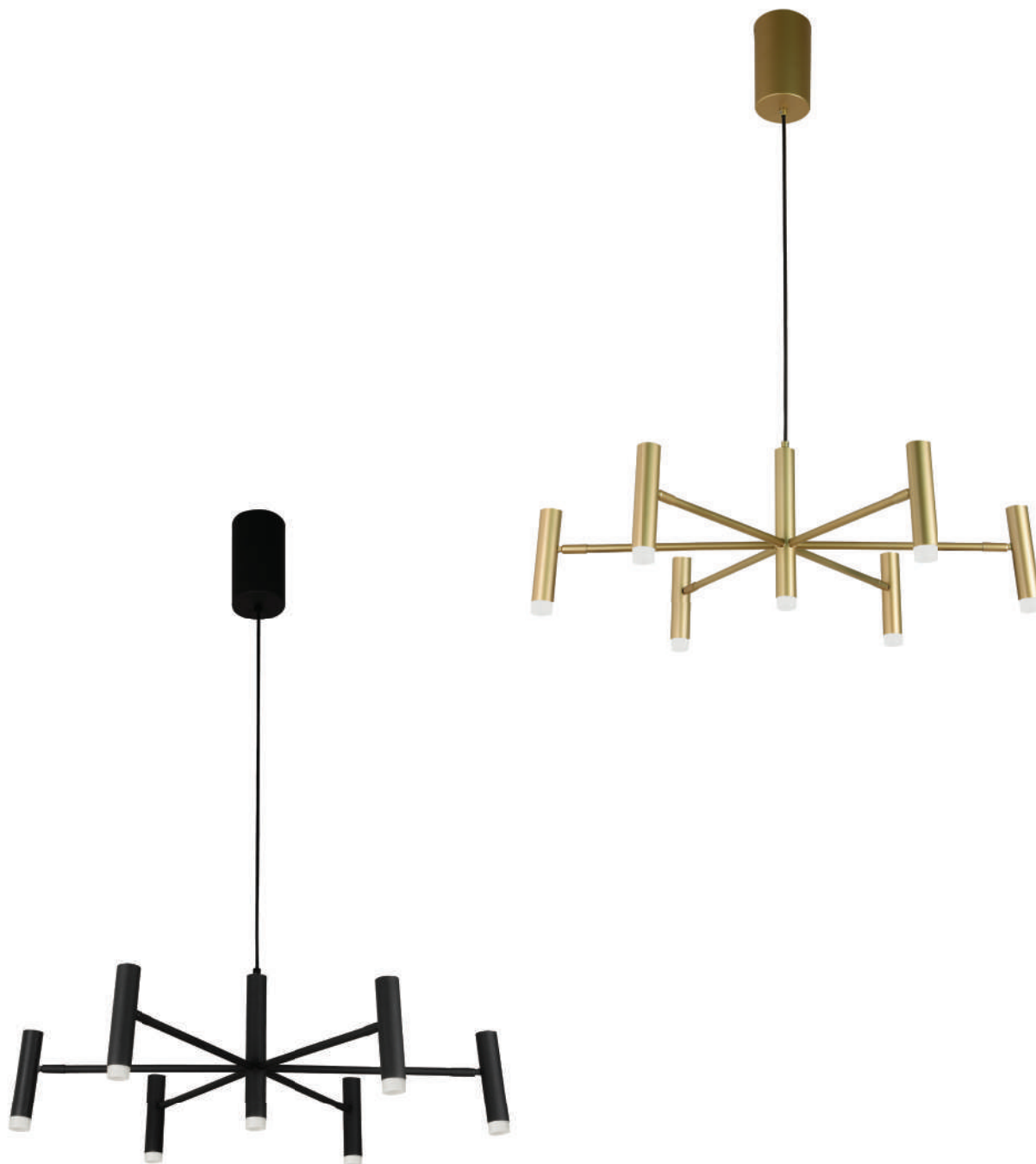

● PD1498DO

● PD1498

Pendente

21W (7x3W) / 1680 lm / 3000K

Dim.: Ø700 x A240 mm

Tensão: Bivolt (127V/220V)

Cabo ajustável até 1500 mm

Zione

Estrutura: Metal

Difusor: Acrílico

Acabamento: Dourado ou preto



Arandela articulável

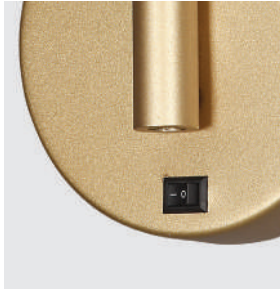

Com interruptor na base



● **AR1600DO**

● **AR1600**

Arandela

LED 1x3W / 240 lm / 3000K
Dim.: C210 x L120 x A355 mm
Tensão: Bivolt (127V/220V)

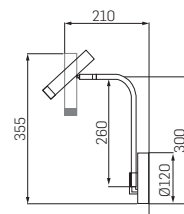

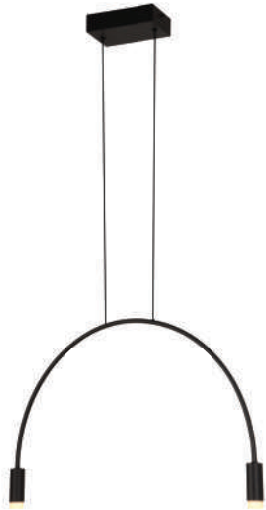

● PD1610DO
● PD1610
Pendente

6W (2x3W) / 480 lm / 3000K
Dim.: C600 x L30 x A370 mm
Tensão: Bivolt (127V/220V)
Cabo ajustável até 1500 mm

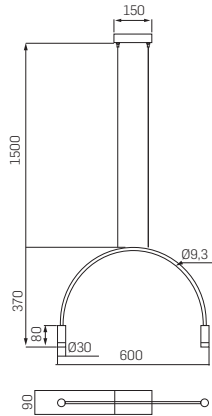
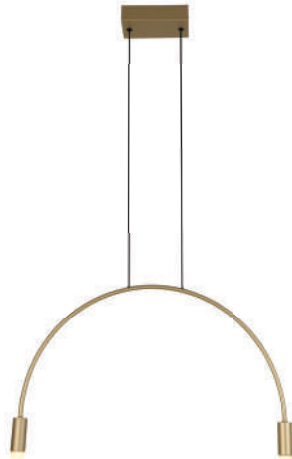

PD16102

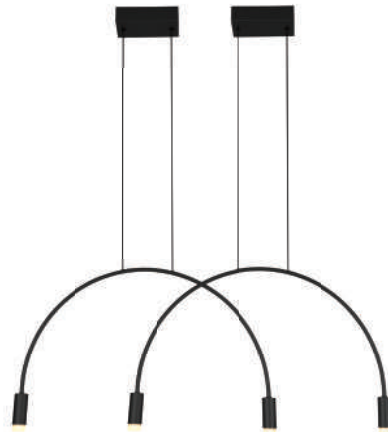

● PD16102DO
● PD16102
Pendente

12W (4x3W) / 960 lm / 3000K
Dim.: C900 x L30 x A370 mm
Tensão: Bivolt (127V/220V)
Cabo ajustável até 1500 mm

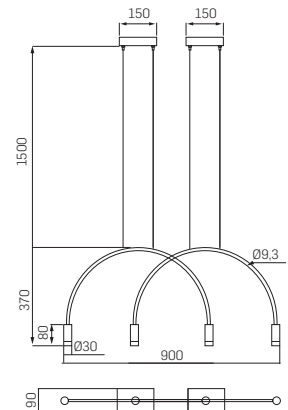
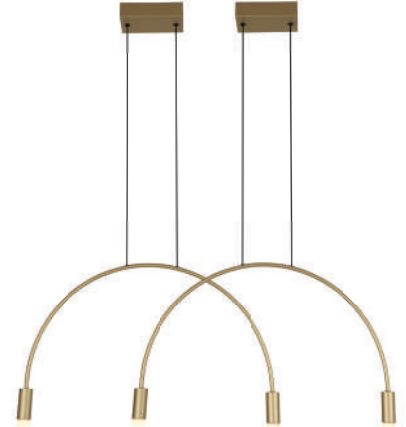

Zione

Estrutura: Metal
 Difusor: Acrílico
 Acabamento: Dourado ou preto



Luminária de mesa e coluna articuláveis



- **LM1601DO**
 - **LM1601**
- Luminária de mesa

LED 1x3W / 240 lm / 3000K
 Dim.: Ø160 x A480 mm
 Tensão: Bivolt (127V/220V)

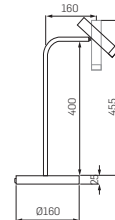

- **LM1489DO**
 - **LM1489**
- Luminária de mesa

LED 2x3W / 480 lm / 3000K
 Dim.: Ø200 x A550 mm
 Tensão: Bivolt (127V/220V)

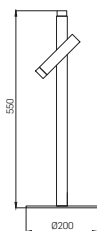

LM1601DO

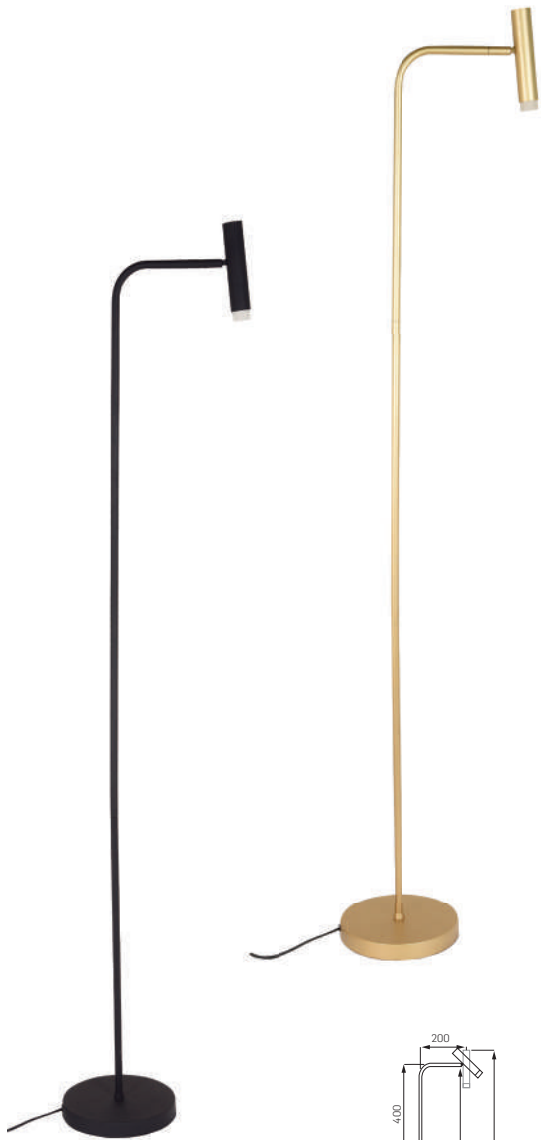

● **CL1602DO**

● **CL1602**

Coluna

LED 1x3W / 240 lm / 3000K
Dim.: Ø200 x A148 mm
Tensão: Bivolt (127V/220V)

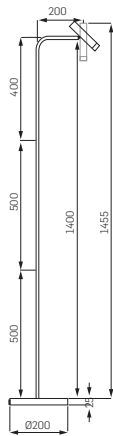

● **CL1490DO**

● **CL1490**

Coluna

LED 2x3W / 480 lm / 3000K
Dim.: Ø250 x A1655 mm
Tensão: Bivolt (127V/220V)

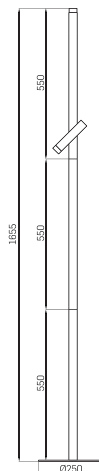

Luminária de mesa e coluna
com dois pontos de luz e
acendimento individual

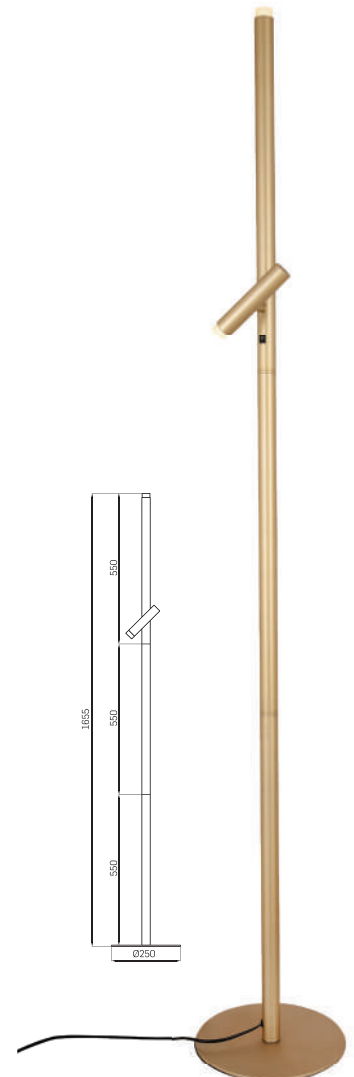

Onna

Metal e Alumínio | Preto e Amadeirado ou Dourado e Madeira

LANÇAMENTO • 2023

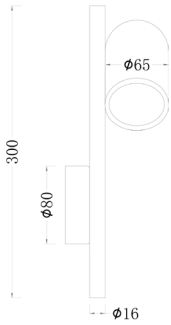

● **AR1834PTMD**
Arandela

1XLED | 5W | 300LM | 3000K
C125XL110XA300mm
Bivolt



● **AR1834DOMD**
Arandela

1XLED | 5W | 300LM | 3000K
C125XL110XA300mm
Bivolt

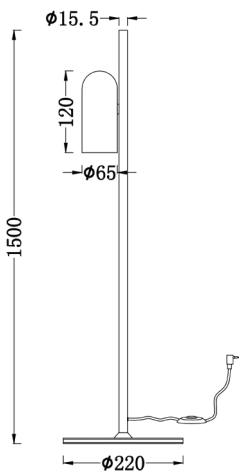

● **CL1837PTMD**
Coluna

1XLED | 5W | 300LM | 3000K
D220XA1500mm
Bivolt



● **CL1837DOMD**
Coluna

1XLED | 5W | 300LM | 3000K
D220XA1500mm
Bivolt

Possui cabo com interruptor liga e desliga para ser ligado a tomada

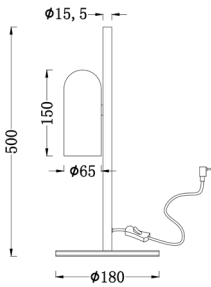

Possui cabo com interruptor liga e desliga para ser ligado a tomada



● **AB1838PTMD**
Abajur

1XLED | 5W | 300LM | 3000K
D180XA500mm
Bivolt



● **AB1838DOMD**
Abajur

1XLED | 5W | 300LM | 3000K
D180XA500mm
Bivolt

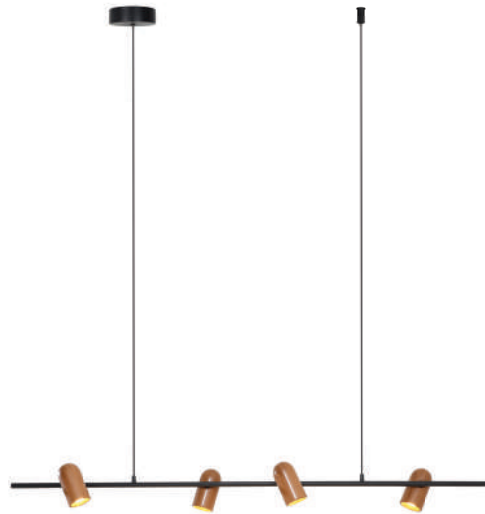

● **PD1835PTMD**
Pendente

4XLED | 20W (4X5W) | 1200LM | 3000K
C1390XL150XA120mm
Bivolt



● **PD1835DOMD**
Pendente

4XLED | 20W (4X5W) | 1200LM | 3000K
C1390XL150XA120mm
Bivolt

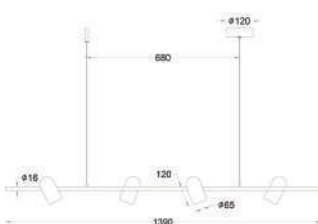

Cabo ajustável até 3000mm

Onna

Metal e Alumínio | Preto e Amadeirado ou Dourado e Amadeirado



Detalhe da peça

LANÇAMENTO • 2023

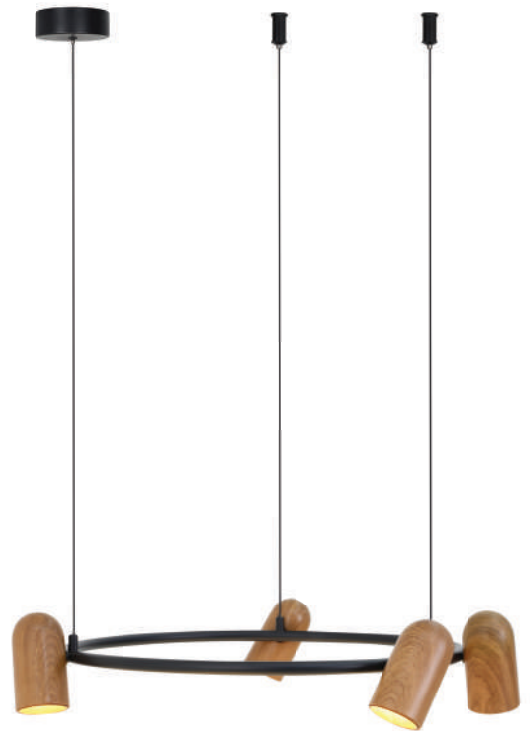

● PD1836PTMD

Pendente

4XLED | 20W MAX | 1200LM | 3000K
D660XA120mm
Bivolt

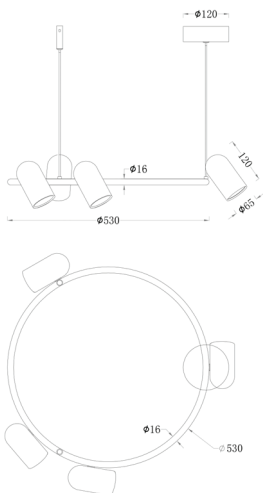

Cabo ajustável até 3000mm

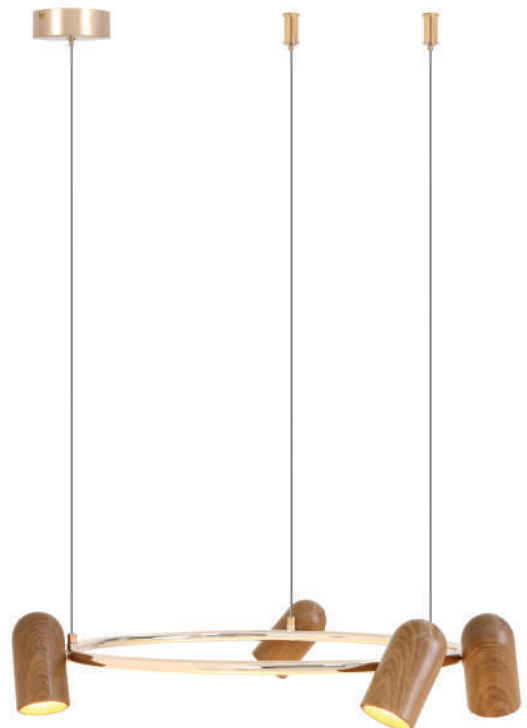

● PD1836DOMD

Pendente

4XLED | 20W MAX | 1200LM | 3000K
D660XA120mm
Bivolt



PD1836PTMD

Cannon

Estrutura: Metal preto

Acabamento detalhe: Preto ou Dourado

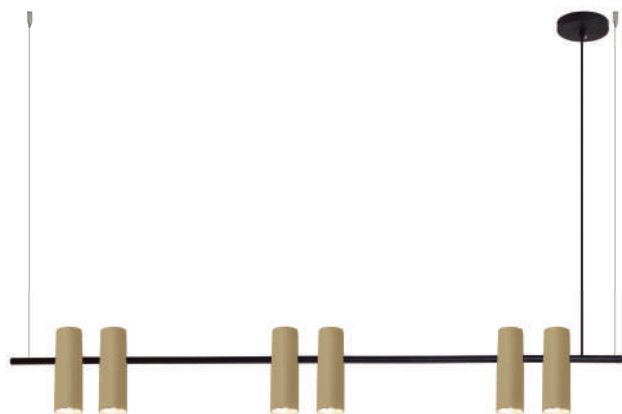
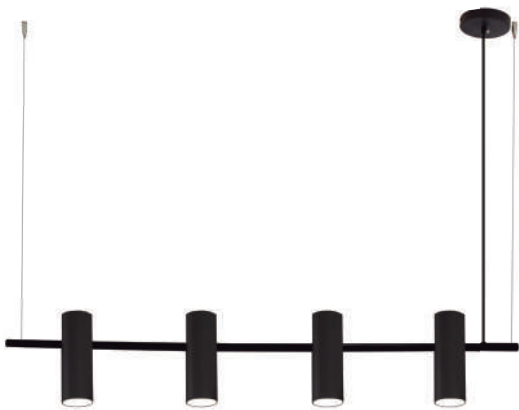

● **PD1632**

Pendente

4xGU10 50W

Dimensões: C1000 x L120 x A170 mm

Tensão: Bivolt (127V/220V)

Potência máxima: 200W

Cabo ajustável de até 1500 mm

● **PD1633DO**

Pendente

6xGU10 50W

Dimensões: C1300 x L120 x A170 mm

Tensão: Bivolt (127V/220V)

Potência máxima: 300W

Cabo ajustável de até 1500 mm

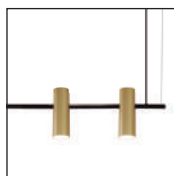
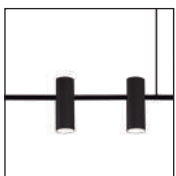

PD1632

Acabamento preto

PD1632DO

Acabamento dourado

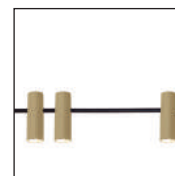
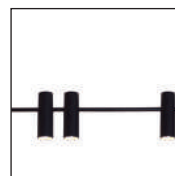

PD1633

Acabamento preto

PD1633DO

Acabamento dourado



PD1633DO

Sears

Estrutura: Metal/cúpula de vidro
 Difusor: Cúpula branca opalina
 Acabamento: Dourado ou Preto



Possibilidade de ajuste de altura



● **PD1629DO**
 Pendente

5xG9 Halopin 5W / 5 xGU10 50W
 Dimensões: C1120 x L260 x A1150 mm
 Tensão: Bivolt (127V/220V)
 Potência máxima: 275W
 Cabo ajustável até 1500 mm

● **PD1611DO**
 Pendente

1xG9 Halopin 5W / 1 xGU10 50W
 Dimensões: C200 x L120 x A1555 mm
 Tensão: Bivolt (127V/220V)
 Potência máxima: 55W

Novo Acabamento



PD1629BR
 Acabamento branco



PD1629DO
 Acabamento dourado



PD1629PT
 Acabamento preto



PD1611DO
 Acabamento dourado



PD1611PT
 Acabamento preto



● **AR1628DO**

Arandela

1xG9 Halopin 5W / 1 xGU10 50W
Dimensões: C235 x A200 mm
Tensão: Bivolt (127V/220V)
Potência máxima: 55W

Novo Acabamento



AR1628BR
Acabamento branco



AR1628DO
Acabamento dourado



AR1628PT
Acabamento preto



AR1628BR

Sears

Estrutura: Metal/cúpula de vidro
 Difusor: Cúpula branca opalina
 Acabamento: Dourado ou Preto



● **CL1630PT**
 Coluna

1xG9 Halopin 5W / 1 xGU10 50W
 Dimensões: C300 x L250 x A1163 mm
 Tensão: Bivolt (127V/220V)
 Potência máxima: 55W
 Possui cabo com interruptor liga e desliga para ser ligado a tomada



● **AB1631DO**
 Abajur

1xG9 Halopin 5W / 1 xGU10 50W
 Dimensões: C230 x L100 x A430 mm
 Tensão: Bivolt (127V/220V)
 Potência máxima: 55W
 Possui cabo com interruptor liga e desliga para ser ligado a tomada

Novo Acabamento



CL1630BR Acabamento branco
CL1630DO Acabamento dourado
CL1630PT Acabamento preto

Novo Acabamento



AB1631BR Acabamento branco
AB1631DO Acabamento dourado
AB1631PT Acabamento preto



AB1631D0

Ludo

Estrutura: Alumínio

Difusor: Preto ou Dourado

Acabamento: Preto

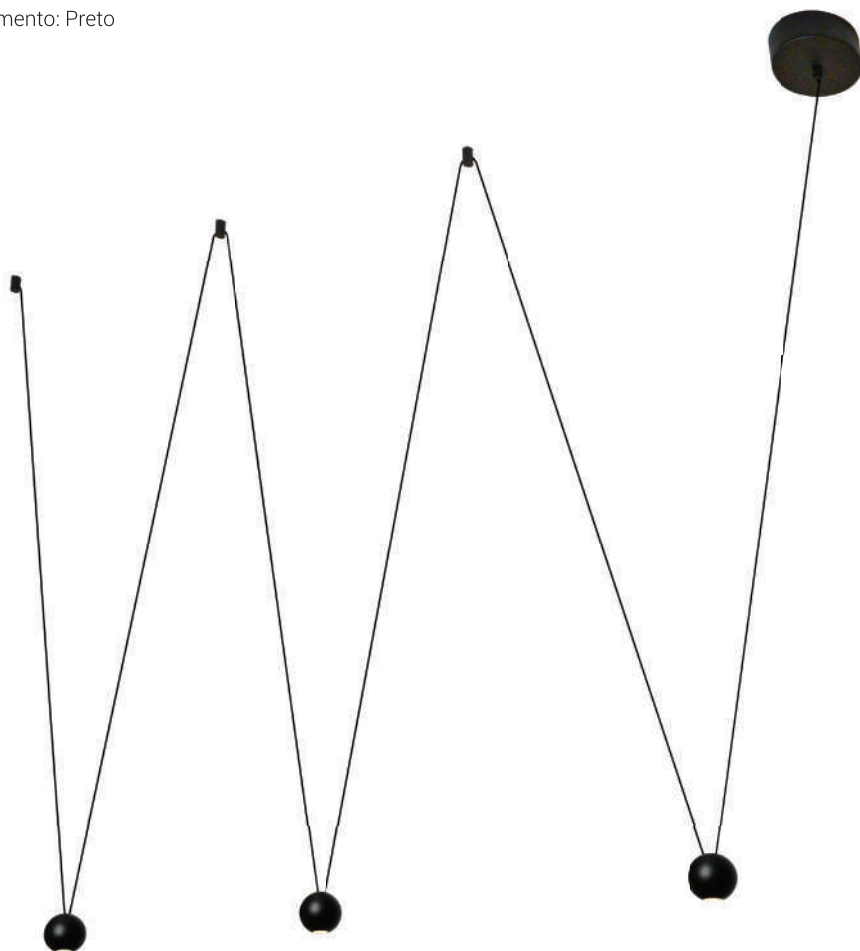

● **PD1645PT**
Pendente

LED 11W
Lúmens: 900lm
Temperatura: 3000K
Dimensões: Ø50 x A1500 mm
Tensão: Bivolt (127V/220V)
Potência máxima: 11W



PD1645DO

PD1645PT



PD1645DO

Sonik

Estrutura: Metal/Alumínio/ Acrílico

Acabamento: Dourado escovado



● **PD1658DO**
Pendente

LED 12W
Lúmens: 600lm
Temperatura: 3000K
Dimensões: C50 x A410 mm
Tensão: Bivolt (127V/220V)
Potência máxima: 12W
Cabo ajustável até 1500 mm



● **AR1657DO**
Arandela

LED 12W
Lúmens: 600lm
Temperatura: 3000K
Dimensões: C50 x A410 mm
Tensão: Bivolt (127V/220V)
Potência máxima: 12W



● **PD1659DO**
Pendente

LED 29W
Lúmens: 1450lm
Temperatura: 3000K
Dimensões: C1010 x A50 mm
Tensão: Bivolt (127V/220V)
Potência máxima: 29W
Cabo ajustável até 1500 mm



PD1659D0

Pectus

Estrutura: Alumínio
 Difusor: Sílica gel branco
 Acabamento: Dourado



● **AR1402**
 Arandela

LED 11W / 880lm / 3000K
 Dimensões: C395 x L145 x A120 mm
 Tensão: Bivolt (127V/220V)

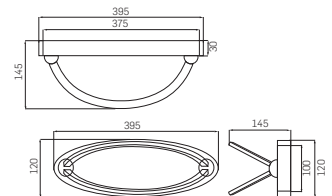

● **PD1401**
 Pendente

LED 54W / 4320lm / 3000K
 Dimensões: Ø800 x A160 mm
 Tensão: Bivolt (127V/220V)
 Cabo ajustável até 1500 mm

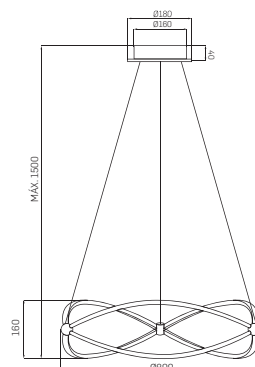



PD1401

Eclipse

Estrutura: Metal + couro marrom

Difusor: Sílica gel

Acabamento: Dourado

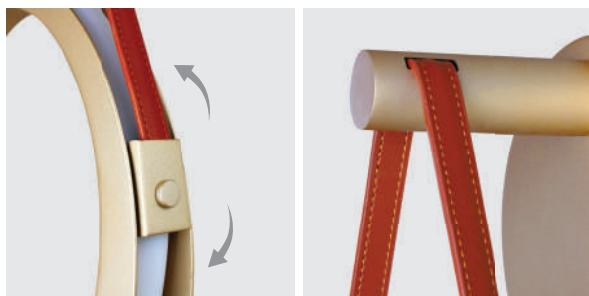

Iluminação em toda parte
externa do aro

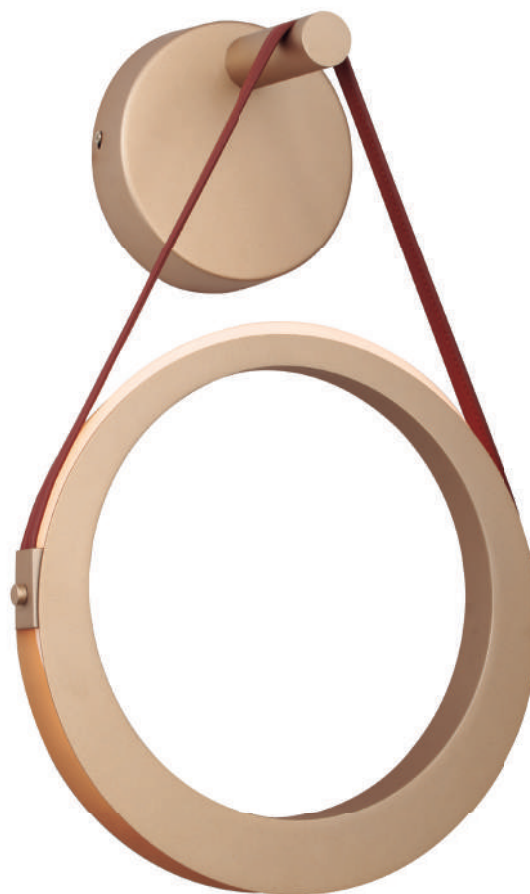

● **AR1504**
Arandela

13W / 780 lm / 3000K
Dimensões: Ø300 x L120 x A551 mm
Tensão: Bivolt (127V/220V)

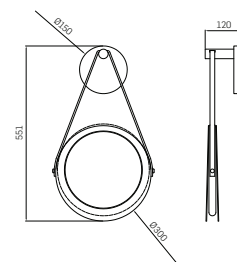

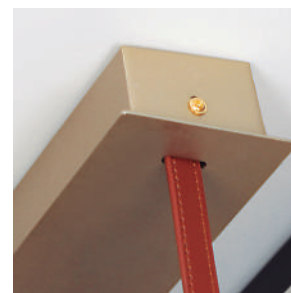
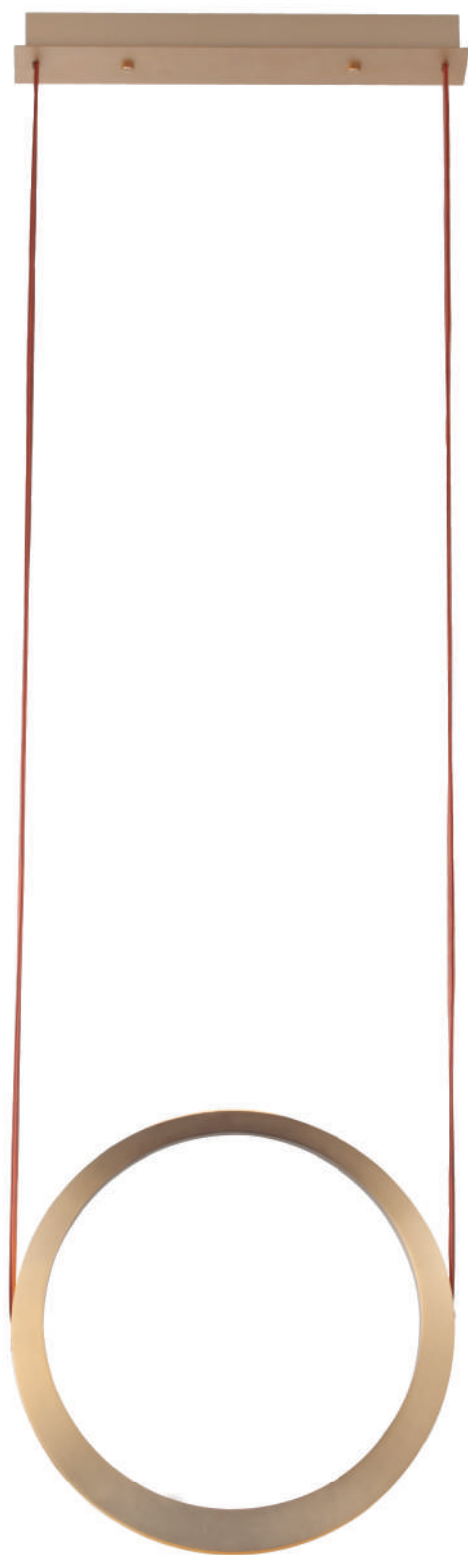

● **PD1505**
Pendente

23W / 1380 lm / 3000K
Dimensões: Ø400 x A1942 mm
Tensão: Bivolt (127V/220V)
Alça de couro ajustável até 1700 mm

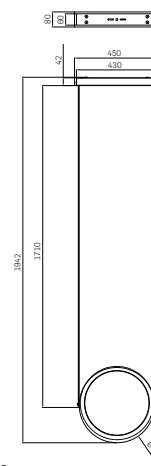

Ritz

Estrutura: Metal/Alumínio/ Acrílico
Difusor: esfera branco opalino
Acabamento: Preto com detalhe dourado

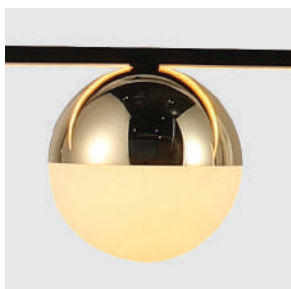

Detalhe do difusor em dourado



● **PD1678**
Pendente

LED 45W
Lúmens: 3150lm
Temperatura: 3000K
Dimensões: C1500 x L100 x A550 mm
Tensão: Bivolt (127V/220V)
Potência máxima: 45W
Cabo ajustável até 1500 mm



● **PD1679**
Pendente

LED 36W
Lúmens: 2520lm
Temperatura: 3000K
Dimensões: C1200 x L100 x A400 mm
Tensão: Bivolt (127V/220V)
Potência máxima: 36W
Cabo ajustável até 1500 mm



PD1678

Onde

Metal | Vidro | Preto ou Dourado

ACIONAMENTO INDIVIDUAL PARA OS 2
CIRCUITOS NA PRÓPRIA PEÇA

LANÇAMENTO • 2023

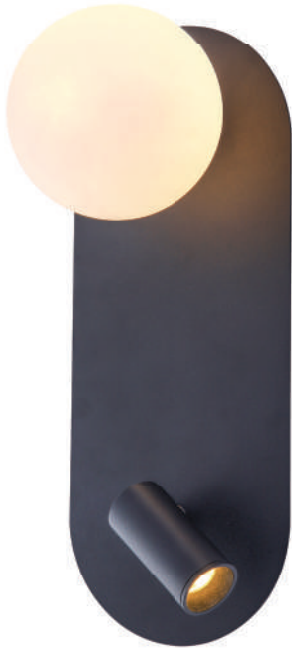

● **AR1798PT**
Arandela

3W 210LM 2700K + 1xG9 (led 5W)
C120XL300XA130mm
Bivolt

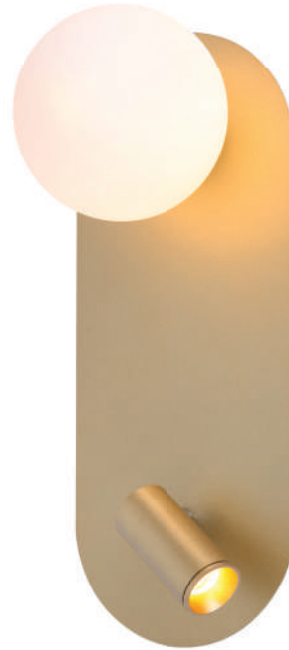

● **AR1798DO**
Arandela

3W 210LM 2700K + 1xG9 (led 5W)
C120XL300XA130mm
Bivolt

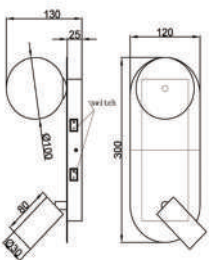



AR1798DO

Malala

_DESIGN
STUDIOLUCE

Metal | Vidro | Preto ou Dourado

LANÇAMENTO • 2023

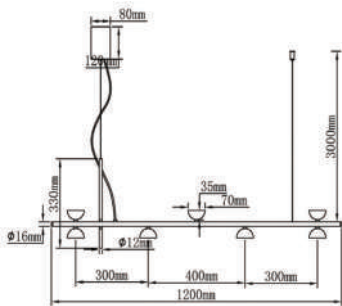

Cabo ajustável até 3000mm



● **PD1823PT**

Pendente

7XLED | 21W | 1470LM | 2700K
C1200XL70XA330mm
Bivolt

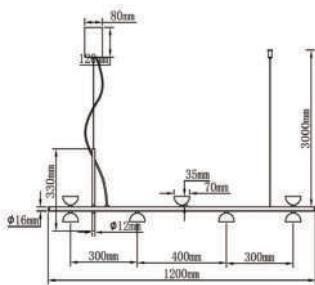

Cabo ajustável até 3000mm



● **PD1823DO**

Pendente

7XLED | 21W | 1470LM | 2700K
C1200XL70XA330mm
Bivolt



PD1823PT

Allure

Estrutura: Metal / Acrílico

Difusor: Acrílico

Acabamento: Preto (onix) / Dourado



● **PD1700X**

Pendente

LED 2X5W
Lúmens: 800lm
Temperatura: 3000K
Dimensões: Ø300 x L65 mm
Tensão: Bivolt (127V/220V)
Potência máxima: 10W
Cabo ajustável até 2000 mm

● **PD1701DO**

Pendente

LED 2X5W
Lúmens: 800lm
Temperatura: 3000K
Dimensões: Ø500 x L65 mm
Tensão: Bivolt (127V/220V)
Potência máxima: 10W
Cabo ajustável até 2000 mm



PD1700DO

PD1700X



PD1701DO

PD1701OX



PD170000X

Fusion

Estrutura: Metal/Alumínio/ Acrílico/ sílica gel

Acabamento: Preto ou dourado



● **PD1680DO**

Pendente

LED 36W

Lúmens: 2520lm

Temperatura: 3000K

Dimensões: C480 x L100 x A660 mm

Tensão: Bivolt (127V/220V)

Potência máxima: 36W

Cabo ajustável até 1500 mm



PD1680DO



PD1680PT



● **PD1681PT**

Pendente

LED 36W

Lúmens: 2520lm

Temperatura: 3000K

Dimensões: C710 x L100 x A516 mm

Tensão: Bivolt (127V/220V)

Potência máxima: 36W

Cabo ajustável até 1500 mm



PD1681DO

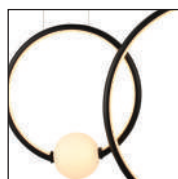

PD1681PT

Mallen

Estrutura: Alumínio/Difusor de sílica gel

Difusor: Difusor branco

Acabamento: Branco, Preto e Dourado

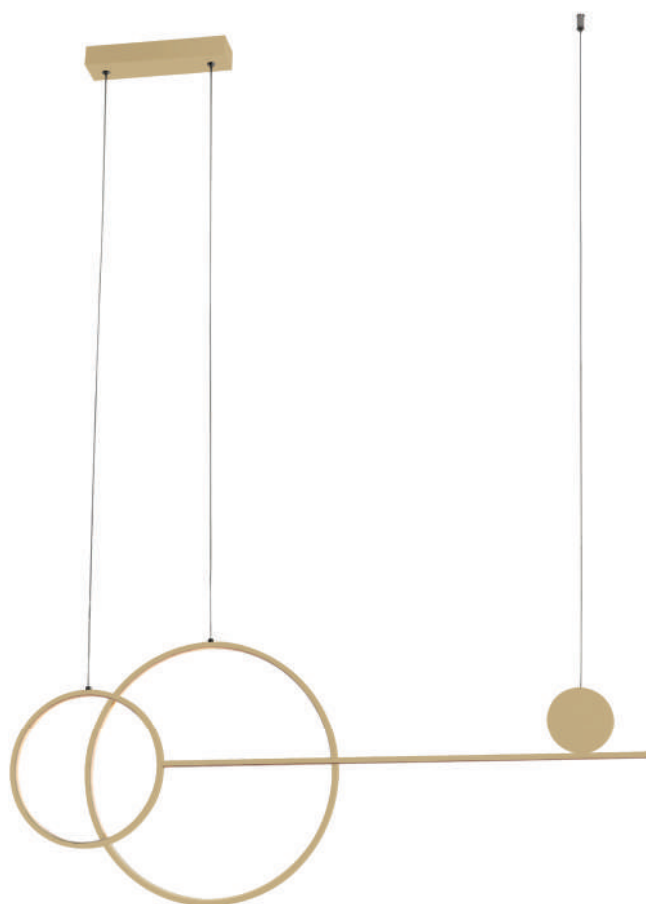

● **PD1627DO**

Pendente

LED: 36W

Lúmens: 2880lm

Temperatura: 3000K

Dimensões: C1200 x L38 x A200 mm

Tensão: Bivolt (127V/220V)

Potência máxima: 36W

Cabo: 1500 mm

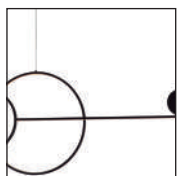

PD1627PT
Acabamento preto

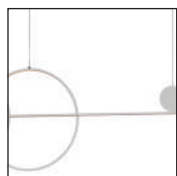

PD1627BR
Acabamento branco

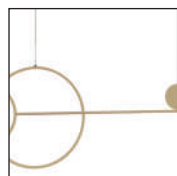

PD1627DO
Acabamento dourado



PD1627PT

Valley

Metal | Dourado, Preto ou Branco

LANÇAMENTO • 2023

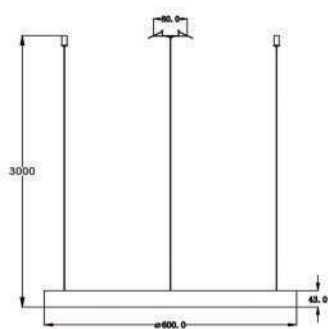

Cabo ajustável até 3000mm



● **PD1691DO**
Pendente

1XLED | 32W | 1530LM | 3000K
D600XA43mm
Bivolt

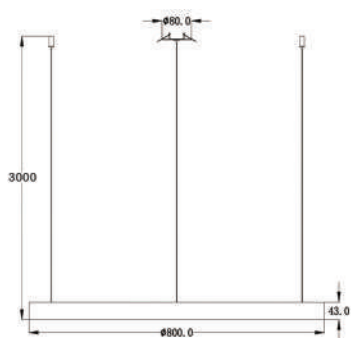

Cabo ajustável até 3000mm



● **PD1692DO**
Pendente

1XLED | 40W | 2000LM | 3000K
D800XA43mm
Bivolt



● **PD1862DO**

Pendente

1XLED | 30W | 1500LM | 3000K
C1145XL400XA43mm
Bivolt



● **PD1862BR**

Pendente

1XLED | 30W | 1500LM | 3000K
C1145XL400XA43mm
Bivolt



● **PD1862PT**

Pendente

1XLED | 30W | 1500LM | 3000K
C1145XL400XA43mm
Bivolt

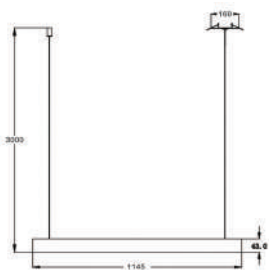

Cabo ajustável até 3000mm



PD1862DO

Valley

Estrutura: Alumínio

Acabamento: Preto ou Branco



● PD1692BR

● PD1692PT
Pendente

LED 40W
Lúmens: 1800lm
Temperatura: 3000K
Dimensões: Ø800 x A43 mm
Tensão: Bivolt (127V/220V)
Potência máxima: 40W
Cabo ajustável até 1500 mm



● PD1691BR

● PD1691PT
Pendente

LED 34W
Lúmens: 1530lm
Temperatura: 3000K
Dimensões: Ø600 x A43 mm
Tensão: Bivolt (127V/220V)
Potência máxima: 34W
Cabo ajustável até 1500 mm

COM EFEITO
DE LUZ
**DIRETA E
INDIRETA**



PD1691BR

Gaia

Metal e Alumínio | Preto, Dourado ou Amadeirado



Detalhe da peça

SENSOR NA PARTE
SUPERIOR DA PEÇA
DIMERIZÁVEL

LANÇAMENTO • 2023



● **PD1831PTMD**

Pendente

1XLED | 48W | 2100LM | 3000K | Dimerizável
C1540XL50XA55mm
Bivolt



● **PD1831PTDO**

Pendente

1XLED | 48W | 2100LM | 3000K | Dimerizável
C1540XL50XA55mm
Bivolt

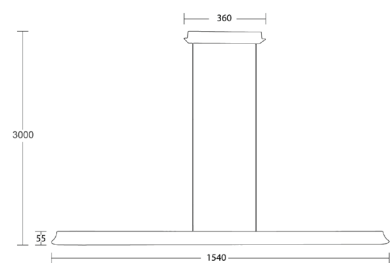

Cabo ajustável até 3000mm

● **PD1831PT**
Pendente

1XLED | 48W | 2100LM | 3000K | Dimerizável
C1540XL50XA55mm
Bivolt



PD1831PTMD

Bert

Estrutura: Alumínio/ Silica gel

Acabamento: Preto, Branco ou Dourado



● **PD1735PT**
Pendente

LED 72W
Lúmens: 3240lm
Temperatura: 3000K
Dimensões: Ø600 + Ø800 x A15 mm
Tensão: Bivolt (127V/220V)
Potência máxima: 72W
Cabo ajustável até 1500 mm



PD1735BR

PD1735PT

PD1735DO



PD1735BR

Rafik

Estrutura: Alumínio/Difusor de sílica gel

Difusor: Difusor branco

Acabamento: Branco, Preto ou Dourado



Canopla compacta exclusiva para forros de gesso



● **PL1619PT**
Plafon

LED: 10W
Lúmens: 800lm
Temperatura: 3000K
Dimensões: C300 x L18 x A200 mm
Tensão: Bivolt (127V/220V)
Potência máxima: 10W



● **PL1620PT**
Plafon

LED: 15W
Lúmens: 1200lm
Temperatura: 3000K
Dimensões: C500 x L80 x A300 mm
Tensão: Bivolt (127V/220V)
Potência máxima: 15W

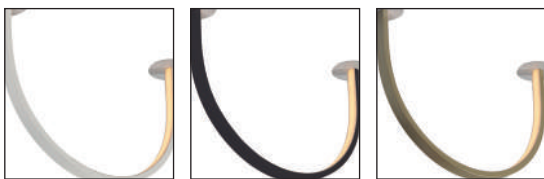

PL1619BR Acabamento branco
PL1619PT Acabamento preto
PL1619DO Acabamento dourado



PL1620BR Acabamento branco
PL1620PT Acabamento preto
PL1620DO Acabamento dourado



● **PL1621PT**
Plafon

LED: 20W
Lúmens: 1600lm
Temperatura: 3000K
Dimensões: C700 x L18 x A400 mm
Tensão: Bivolt (127V/220V)
Potência máxima: 10W



PL1621BR
Acabamento branco



PL1621PT
Acabamento preto



PL1621DO
Acabamento dourado

Sugestões de composição

A

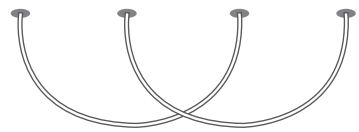

B

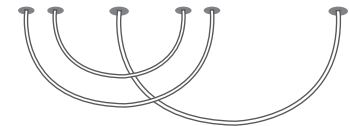

C

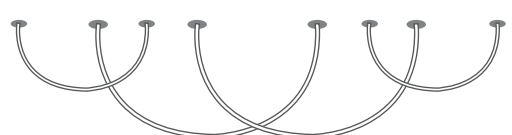

Rafik

Estrutura: Alumínio/Difusor de sílica gel
 Difusor: Difusor branco
 Acabamento: Branco, Preto ou Dourado



Canopla compacta exclusiva para forros de gesso

Sugestões de composição

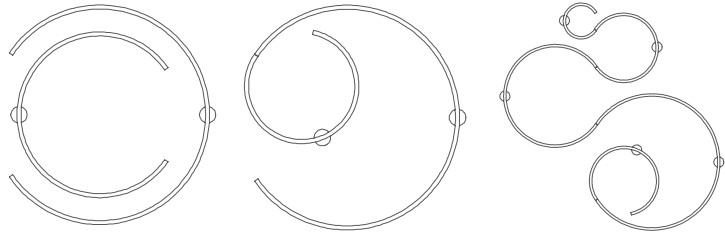

● PL1622BR

Plafon

LED: 8W
 Lúmens: 640lm
 Temperatura: 3000K
 Dimensões: Ø200 x A20 mm
 Tensão: Bivolt (127V/220V)
 Potência máxima: 8W



● PL1623BR

Plafon

LED: 15W
 Lúmens: 1200lm
 Temperatura: 3000K
 Dimensões: Ø400 x A20 mm
 Tensão: Bivolt (127V/220V)
 Potência máxima: 15W



PL1622BR
Acabamento branco

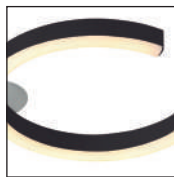

PL1622PT
Acabamento preto

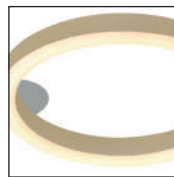

PL1622DO
Acabamento dourado



PL1623BR
Acabamento branco

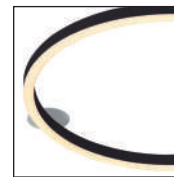

PL1623PT
Acabamento preto

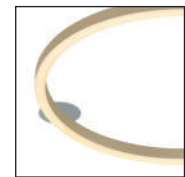

PL1623DO
Acabamento dourado

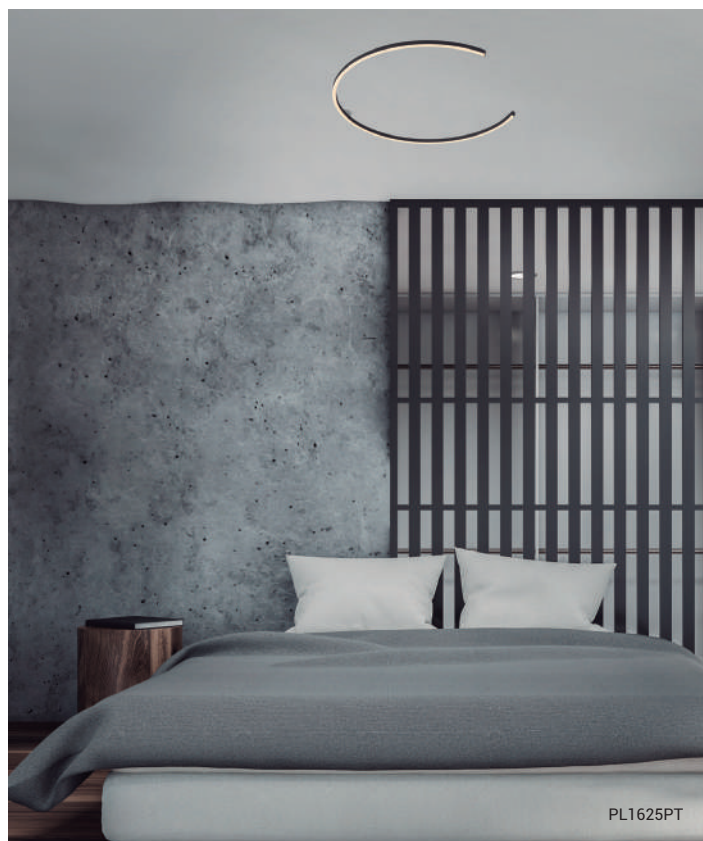

● **PL1624BR**
Plafon

LED: 25W
Lúmens: 2000lm
Temperatura: 3000K
Dimensões: Ø600 x A20 mm
Tensão: Bivolt (127V/220V)
Potência máxima: 25W



PL1624BR
Acabamento branco

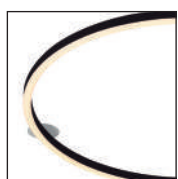

PL1624PT
Acabamento preto

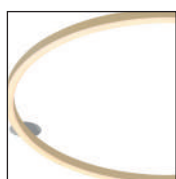

PL1624DO
Acabamento dourado



● **PL1625BR**
Plafon

LED: 30W
Lúmens: 2400lm
Temperatura: 3000K
Dimensões: Ø800 x A20 mm
Tensão: Bivolt (127V/220V)
Potência máxima: 30W



PL1625BR
Acabamento branco

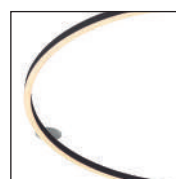

PL1625PT
Acabamento preto



PL1625DO
Acabamento dourado

Quebec

Estrutura: Metal, detalhes em alumínio/

Difusor de sílica gel

Difusor: Difusor branco

Acabamento: Branco, Preto, Dourado
ou Cobre



● **QPD1435CO**
Pendente

LED: 45W

Lúmens: 1962lm

Temperatura: 3000K

Dimensões: Ø400+Ø500 x A20 mm

Tensão: Bivolt (127V/220V)

Potência máxima: 45W

Cabo ajustável até 1500 mm



QPD1435BR
Acabamento branco



QPD1435PT
Acabamento preto

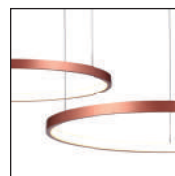

QPD1435CO
Acabamento cobre



QPD1435DO
Acabamento dourado



QPD1435PT

Quebec

Estrutura: Alumínio/Difusor de sílica gel

Difusor: Difusor branco

Acabamento: Branco, Preto, Dourado
ou Cobre

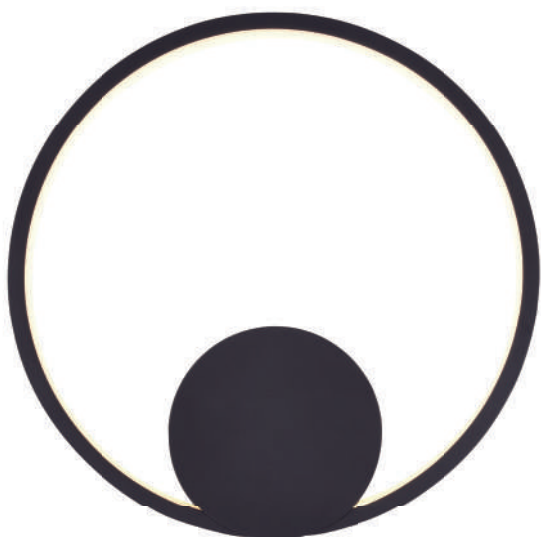

● **QAR1436PT**
Arandela/Plafon

LED: 15W
Lúmens: 650lm
Temperatura: 3000K
Dimensões: Ø300 mm
Tensão: Bivolt (127V/220V)
Potência máxima: 15W



QAR1436BR
Acabamento branco

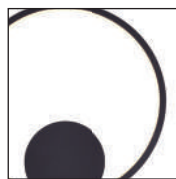

QAR1436PT
Acabamento preto

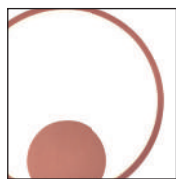

QAR1436CO
Acabamento cobre

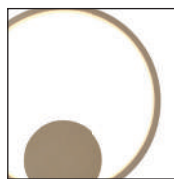

QAR1436DO
Acabamento dourado





Montreal

Estrutura: Alumínio/Difusor de sílica gel

Difusor: branco

Acabamento: Branco, Preto, Dourado
ou Cobre



● **QPD1301-PT**
Pendente

LED: 25W + 15W
Lúmens: 2254lm
Temperatura: 3000K
Dimensões: Ø500 + Ø300 x A20 mm
Tensão: Bivolt (127V/220V)
Potência máxima: 40W
Cabo ajustável até 1500 mm



QPD1301-BR
Acabamento branco

QPD1301-PT
Acabamento preto

QPD1301-CO
Acabamento cobre

QPD1301-DO
Acabamento dourado



● **QPD1303-DO**
Pendente

LED: 24W + 30W + 35W
Lúmens: 4181lm
Temperatura: 3000K
Dimensões: Ø600 + Ø500 + Ø400 x A20 mm
Tensão: Bivolt (127V/220V)
Potência máxima: 89W
Cabo ajustável até 1500 mm



QPD1303-BR
Acabamento branco



QPD1303-PT
Acabamento preto



QPD1303-CO
Acabamento cobre



QPD1303-DO
Acabamento dourado

Orgon

Estrutura: Alumínio/Difusor de sílica gel

Difusor: Difusor branco

Acabamento: Branco, Preto, Dourado
ou Cobre



● **PD1424PT**
Pendente

LED: 45W
Lúmens: 2500lm
Temperatura: 3000K
Dimensões: Ø500 xA180 mm
Tensão: Bivolt (127V/220V)
Potência máxima: 45W
Cabo ajustável até 1500 mm



PD1424BR
Acabamento branco

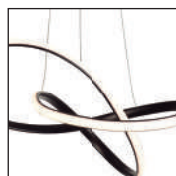

PD1424PT
Acabamento preto



PD1424CO
Acabamento cobre



PD1424DO
Acabamento dourado



● **PD1423CO**
Pendente

LED: 58W
Lúmens: 2800lm
Temperatura: 3000K
Dimensões: Ø800 x A180 mm
Tensão: Bivolt (127V/220V)
Potência máxima: 58W
Cabo ajustável até 1500 mm

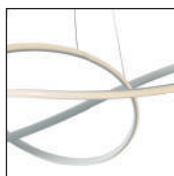

PD1423BR
Acabamento branco

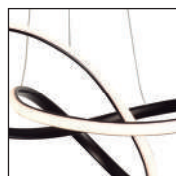

PD1423PT
Acabamento preto

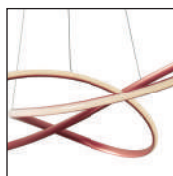

PD1423CO
Acabamento cobre



PD1423DO
Acabamento dourado

Volta

Metal | Silicone | Preto ou Dourado

LANÇAMENTO • 2023

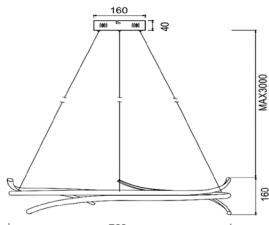

Cabo ajustável até 3000mm



● **PD1777PT**
Pendente

1XLED | 36W | 2880LM | 3000K
D700XA160mm
Bivolt



● **PD1777DO**
Pendente

1XLED | 36W | 2880LM | 3000K
D700XA160mm
Bivolt

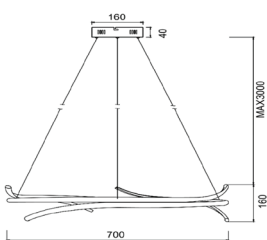

Cabo ajustável até 3000mm



PD1777PT

Maré

Metal | Silicone | Branco ou Dourado

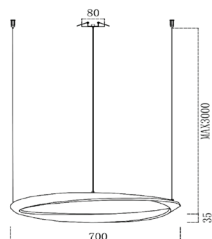

Cabo ajustável até 3000mm



● **PD1778BR**
Pendente

1XLED | 27W | 2160LM | 3000K
D700XA35mm
Bivolt

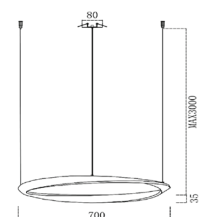

Cabo ajustável até 3000mm



● **PD1778DO**
Pendente

1XLED | 27W | 2160LM | 3000K
D700XA35mm
Bivolt



PD1778DO

Numa

Metal | Silicone | Dourado, Branco ou Preto

LANÇAMENTO • 2023



● **PD1779PT**
Pendente

1XLED | 27W | 2160LM | 3000K
D600XA20mm
Bivolt

● **PD1780PT**
Pendente

1XLED | 36W | 2880LM | 3000K
D800XA20mm
Bivolt

● **PD1781PT**
Pendente

1XLED | 45W | 3600LM | 3000K
D1000XA20mm
Bivolt

● **PD1779DO**
Pendente

1XLED | 27W | 2160LM | 3000K
D600XA20mm
Bivolt

● **PD1780DO**
Pendente

1XLED | 36W | 2880LM | 3000K
D800XA20mm
Bivolt

● **PD1781DO**
Pendente

1XLED | 45W | 3600LM | 3000K
D1000XA20mm
Bivolt

● **PD1779BR**
Pendente

1XLED | 27W | 2160LM | 3000K
D600XA20mm
Bivolt

● **PD1780BR**
Pendente

1XLED | 36W | 2880LM | 3000K
D800XA20mm
Bivolt

● **PD1781BR**
Pendente

1XLED | 45W | 3600LM | 3000K
D1000XA20mm
Bivolt

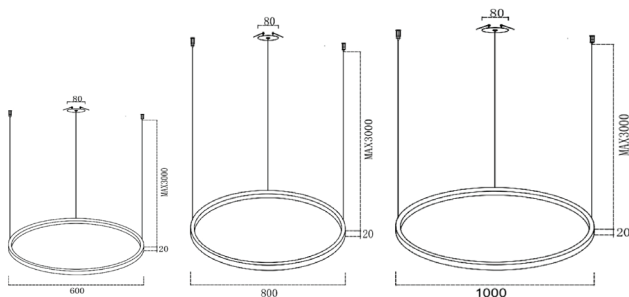

Cabo ajustável até 3000mm



PD1779DO, PD1780DO e PD1781DO

Numa

Metal | Silicone | Dourado, Branco ou Preto - **Versão com Rebatedor**

LANÇAMENTO • 2023



● **PD1779PTAC003**
Pendente

1XLED | 27W | 2160LM | 3000K
D600XA20mm
Bivolt

● **PD1780PTAC004**
Pendente

1XLED | 36W | 2880LM | 3000K
D800XA20mm
Bivolt

● **PD1781PTAC005**
Pendente

1XLED | 45W | 3600LM | 3000K
D1000XA20mm
Bivolt

● **PD1779DOAC003**
Pendente

1XLED | 27W | 2160LM | 3000K
D600XA20mm
Bivolt

● **PD1780DOAC004**
Pendente

1XLED | 36W | 2880LM | 3000K
D800XA20mm
Bivolt

● **PD1781DOAC005**
Pendente

1XLED | 45W | 3600LM | 3000K
D1000XA20mm
Bivolt

● **PD1779BRAC003**
Pendente

1XLED | 27W | 2160LM | 3000K
D600XA20mm
Bivolt

● **PD1780BRAC004**
Pendente

1XLED | 36W | 2880LM | 3000K
D800XA20mm
Bivolt

● **PD1781BRAC005**
Pendente

1XLED | 45W | 3600LM | 3000K
D1000XA20mm
Bivolt

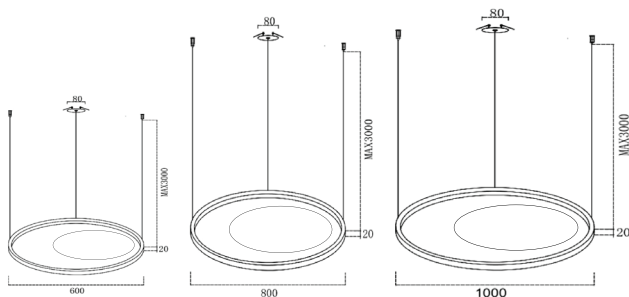

Cabo ajustável até 3000mm



PD1779BRAC003 e PD1779DOAC003

Lace

Estrutura: Alumínio/Difusor de sílica gel

Difusor: Difusor branco

Acabamento: Preto ou Dourado



● **PD1425DO**

Pendente

LED: 36W

Lúmens: 1500lm

Temperatura: 3000K

Dimensões: C1000 x L250 x A250 mm

Tensão: Bivolt (127V/220V)

Potência máxima: 36W

Cabo ajustável até 1500 mm



PD1425PT

Acabamento preto

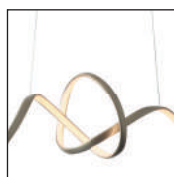

PD1425DO

Acabamento dourado

Worm

Estrutura: Alumínio/Difusor de sílica gel
 Difusor: Difusor branco
 Acabamento: Branco, Preto, Dourado
 ou Cobre



PD1427DO



● **AR1426BR**
 Arandela

LED: 10W
 Lúmens: 770lm
 Temperatura: 3000K
 Dimensões: C160 x L140 x A320 mm
 Tensão: Bivolt (127V/220V)
 Potência máxima: 10W



● **PD1427DO**
 Pendente

LED: 30W
 Lúmens: 1300lm
 Temperatura: 3000K
 Dimensões: Ø180 x A550 mm
 Tensão: Bivolt (127V/220V)
 Potência máxima: 30W
 Cabo ajustável até 1500 mm



AR1426BR
 Acabamento branco



AR1426PT
 Acabamento preto



AR1426CO
 Acabamento cobre



AR1426DO
 Acabamento dourado



PD1427DO
 Acabamento
 dourado

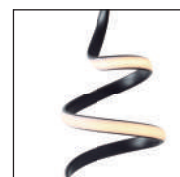

PD1427PT
 Acabamento preto

Twine

Estrutura: Alumínio/Difusor de sílica gel

Difusor: Difusor branco

Acabamento: Branco, Preto, Dourado
ou Cobre



QPD1339PT



● **QPD1339DO**
Pendente

LED: 15W

Lúmens: 900lm

Temperatura: 3000K

Dimensões: C880 x A70 mm

Tensão: Bivolt (127V/220V)

Potência máxima: 15W

Cabo ajustável até 1500 mm



QPD1339BR
Acabamento branco



QPD1339PT
Acabamento preto

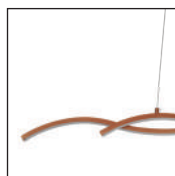

QPD1339CO
Acabamento cobre

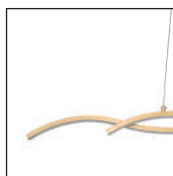

QPD1339DO
Acabamento dourado

Tagne

Estrutura: Alumínio/Difusor de sílica gel

Difusor: Difusor branco

Acabamento: Branco, Preto e Dourado



Canopla compacta exclusiva para forros de gesso



PD1626BR

● **PD1626PT**
Pendente

LED: 24W
Lúmens: 1920lm
Temperatura: 3000K
Dimensões: C900 x L38 x A100 mm
Tensão: Bivolt (127V/220V)
Potência máxima: 24W
Cabo ajustável até 1500 mm



PD1626BR
Acabamento branco

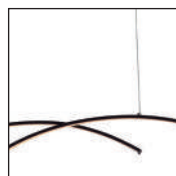

PD1626PT
Acabamento preto

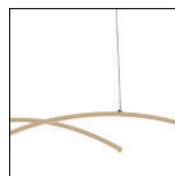

PD1626DO
Acabamento dourado

Hoop

Estrutura: Alumínio/Difusor de sílica gel

Difusor: Difusor branco

Acabamento: Branco, Preto, Dourado
ou Cobre



● **QPD1321BR**
Pendente

LED: 16W
Lúmens: 688lm
Temperatura: 3000K
Dimensões: C120 x A35 mm
Tensão: Bivolt (127V/220V)
Potência máxima: 16W
Cabo ajustável até 1500 mm

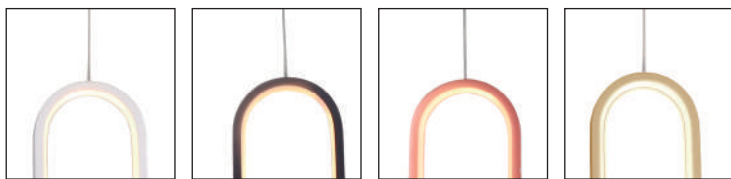

QPD1321BR
Acabamento branco

QPD1321PT
Acabamento preto

QPD1321CO
Acabamento cobre

QPD1321DO
Acabamento dourado



QPD1321PT

Volpi

Estrutura: Metal/ Alumínio/ Sílica gel
Acabamento: Preto, branco ou dourado

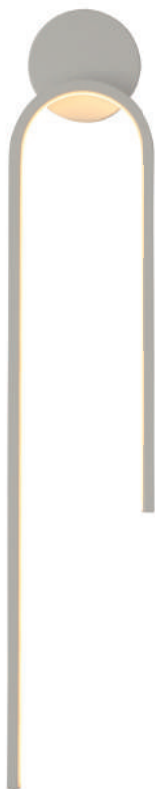
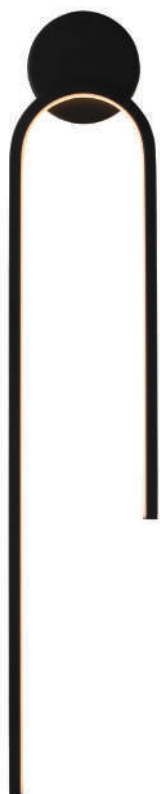

● **AR1669PT**
Arandela

LED 10W
Lúmens: 700lm
Temperatura: 3000K
Dimensões: C140 x L22 x A650 mm
Tensão: Bivolt (127V/220V)
Potência máxima: 10W

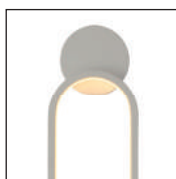

AR1669BR



AR1669PT



AR1669DO



AR1669PT

Kira

Estrutura: Alumínio/ Sílica gel

Acabamento: Preto, branco ou dourado

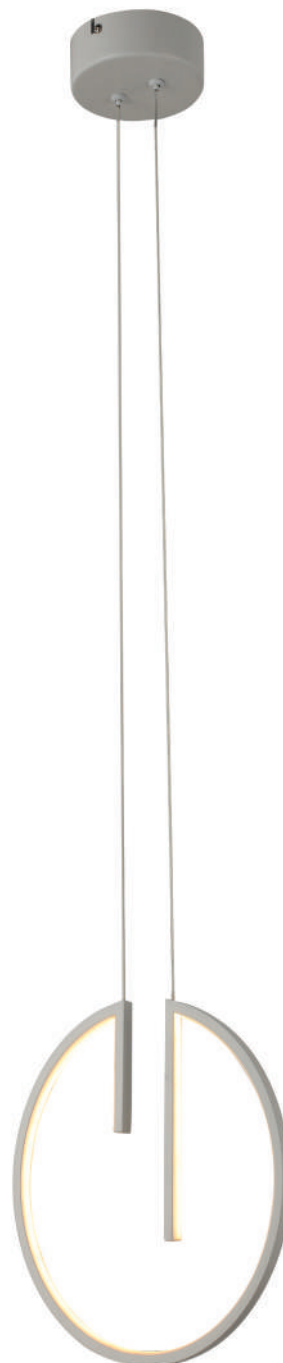
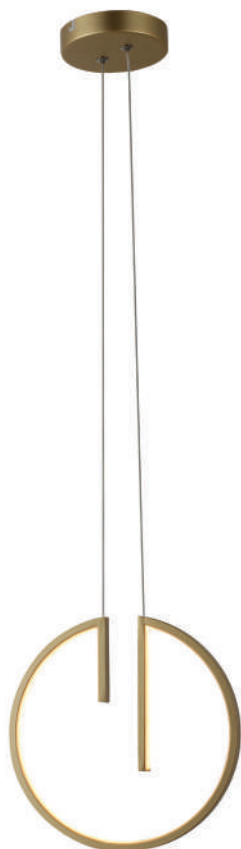
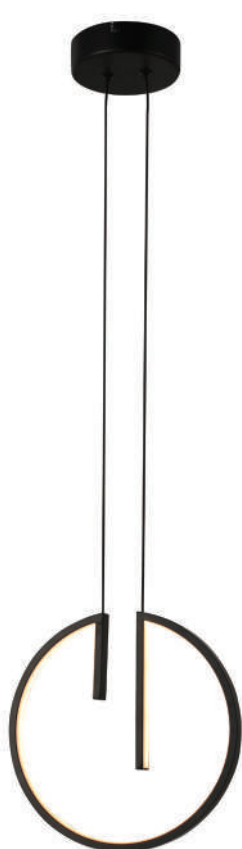

● **PD1617PT**
Pendente

LED 18W
Lúmens: 1260lm
Temperatura: 3000K
Dimensões: C240 x L20 x A238 mm
Tensão: Bivolt (127V/220V)
Potência máxima: 18W
Cabo ajustável até 1500 mm

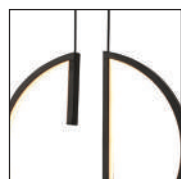

PD1617BR

PD1617PT

PD1617DO



PT 1617PT

Avis

Estrutura: Alumínio/ Sílica gel

Acabamento: Preto, branco ou dourado



● **AR1689DO**
Arandela

LED 15W
Lúmens: 1050lm
Temperatura: 3000K
Dimensões: C600 x L35 x A148 mm
Tensão: Bivolt (127V/220V)
Potência máxima: 15W

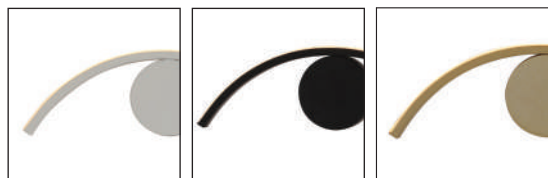

AR1689BR

AR1689PT

AR1689DO



● **AR1690PT**

Arandela

LED 20W

Lúmens: 1400lm

Temperatura: 3000K

Dimensões: C1000 x L35 x A290 mm

Tensão: Bivolt (127V/220V)

Potência máxima: 20W

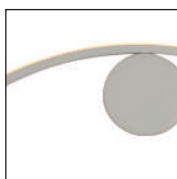

AR1690BR

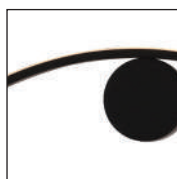

AR1690PT

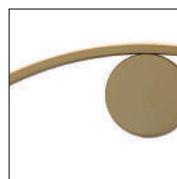

AR1690DO

Calla

Estrutura: Metal/Alumínio/ Acrílico

Acabamento: Preto, Branco ou Dourado



● **AR1653DO**
Arandela

LED 6W
Lúmens: 300lm
Temperatura: 3000K
Dimensões: Ø150 mm
Tensão: Bivolt (127V/220V)
Potência máxima: 6W

● **AR1655PT**
Arandela

LED 6W
Lúmens: 300lm
Temperatura: 3000K
Dimensões: C120 x L40 x A110 mm
Tensão: Bivolt (127V/220V)
Potência máxima: 6W

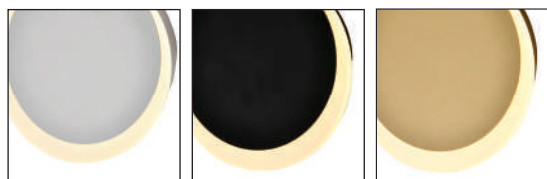

AR1653BR

AR1653PT

AR1653DO

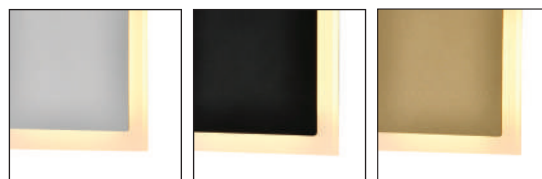

AR1655BR

AR1655PT

AR1655DO



● **PD1652BR**
Pendente

LED 6W
Lúmens: 300lm
Temperatura: 3000K
Dimensões: Ø150 mm
Tensão: Bivolt (127V/220V)
Potência máxima: 6W
Cabo ajustável até 1500 mm

● **PD1654PT**
Pendente

LED 6W
Lúmens: 300lm
Temperatura: 3000K
Dimensões: C120 x L10 x A110 mm
Tensão: Bivolt (127V/220V)
Potência máxima: 6W
Cabo ajustável até 1500 mm

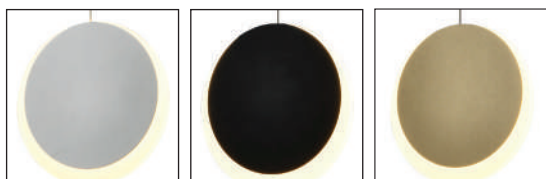

PD1652BR

PD1652PT

PD1652DO



PD1654BR

PD1654PT

PD1654DO

Baba

Metal | Acrílico | Preto, Branco ou Dourado

LANÇAMENTO • 2023

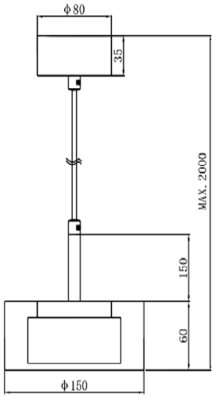

Cabo ajustável até 2000mm

PODE SER INSTALADO COMO
PENDENTE OU PLAFON



● **PD1782PT**

Pendente / Plafon

1XLED | 7W | 500LM | 3000K
D150XL150XA60mm
Bivolt



● **PD1782BR**

Pendente / Plafon

1XLED | 7W | 500LM | 3000K
D150XL150XA60mm
Bivolt



● **PD1782DO**

Pendente / Plafon

1XLED | 7W | 500LM | 3000K
D150XL150XA60mm
Bivolt



● **PD1820**
Pendente

3XLED | 21W | 1500LM | 3000K
C1080XL150XA85mm
Bivolt

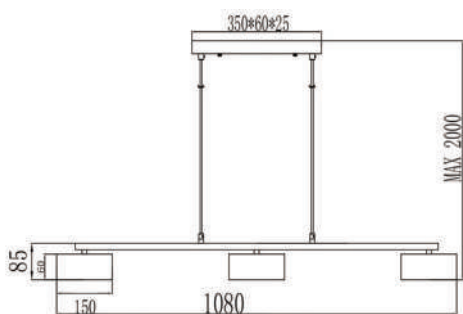

Cabo ajustável até 3000mm

Disco

Metal | Acrílico | Preto ou Dourado

LANÇAMENTO • 2023



Detalhe da peça



● **PD1802DO**
Pendente

1XLED | 7W | 560LM | 3000K
D400XA161mm
Bivolt



● **PD1802**
Pendente

1XLED | 7W | 560LM | 3000K
D400XA161mm
Bivolt

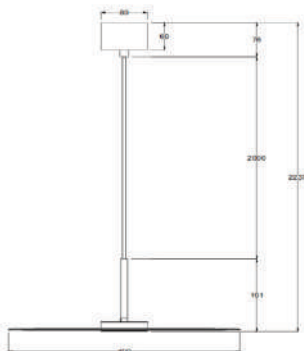

Cabo ajustável até 2000mm



PD1802

Coco

Metal | Acrílico | Preto e Dourado ou Fendi e Dourado

LANÇAMENTO • 2023

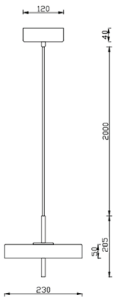

Cabo ajustável até 2000mm



● **PD1814PT**
Pendente

12W | 300LM | 3000K
D23XA20,5CM
Bivolt



● **PD1814FD**
Pendente

12W | 300LM | 3000K
D23XA20,5CM
Bivolt

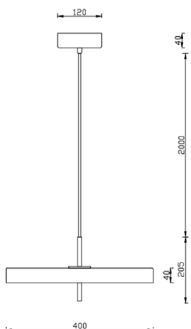

Cabo ajustável até 2000mm



● **PD1815PT**
Pendente

24W | 880LM | 3000K
D40XA20,5CM
Bivolt



● **PD1815FD**
Pendente

24W | 880LM | 3000K
D40XA20,5CM
Bivolt

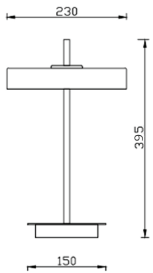

Possui cabo com interruptor liga e desliga para ser ligado a tomada



● **AB1816PT**
Abajur

12W | 300LM | 3000K
D23XA39,5CM
Bivolt



● **AB1816FD**
Abajur

12W | 300LM | 3000K
D23XA39,5CM
Bivolt



PD1815FD

Dover

Estrutura: Alumínio

Disco: Branco

Acabamento: Preto / Dourado



● **PL1644PT**
Plafon

LED 10.5W
Lúmens: 1100lm
Temperatura: 3000K
Dimensões: Ø300 x A223 mm
Tensão: Bivolt (127V/220V)
Potência máxima: 10.5W



PL1644DO

PL1644PT



● **PD1643DO**
Pendente

LED 10.5W
Lúmens: 1050lm
Temperatura: 3000K
Dimensões: Ø400 x A580 mm
Tensão: Bivolt (127V/220V)
Potência máxima: 10.5W
Cabo ajustável até 1500 mm



PD1643DO

PD1643PT



PD1643PT

Asha

Estrutura: Metal/Alumínio/ Acrílico

Acabamento: Preto ou Branco



● **PL1656BR**
Plafon/Arandela

LED 30W
Lúmens: 1500lm
Temperatura: 3000K
Dimensões: C800 x L660 x P85 mm
Tensão: Bivolt (127V/220V)
Potência máxima: 30W



PL1656BR

PL1656PT



PL1656PT

Berla

Estrutura: Metal/acrílico

Acabamento: Branco



● **PL1749**

Plafon

LED 33W
Lúmens: 2376lm
Temperatura: 3000K
Dimensões: C620 x L500 x P50 mm
Tensão: Bivolt (127V/220V)
Potência máxima: 33W



● **PL1750**

Plafon

LED 31W
Lúmens: 2232lm
Temperatura: 3000K
Dimensões: C600 x L580 x P50 mm
Tensão: Bivolt (127V/220V)
Potência máxima: 31W

Dupe

Estrutura: Metal/ Acrílico

Acabamento: Branco



● **PL1664**
Plafon

LED 22W
Lúmens: 1500lm
Temperatura: 3000K
Dimensões: C545 x L405 x A50 mm
Tensão: Bivolt (127V/220V)
Potência máxima: 22W



Luft

Estrutura: Metal/ Acrílico

Acabamento: Branco



● **PL1666**
Plafon

LED 60W
Lúmens: 3900lm
Temperatura: 3000K
Dimensões: C750 x L500 x A80 mm
Tensão: Bivolt (127V/220V)
Potência máxima: 60W

Mob

Estrutura: Metal/ Acrílico

Acabamento: Branco fosco / Preto fosco



● **PL1663PT**
Plafon

LED 24W
Lúmens: 1600lm
Temperatura: 3000K
Dimensões: C400 x L305 x A30 mm
Tensão: Bivolt (127V/220V)
Potência máxima: 18W



● **PL1662BR**
Plafon

LED 18W
Lúmens: 1200lm
Temperatura: 3000K
Dimensões: C300 x L210 x A30 mm
Tensão: Bivolt (127V/220V)
Potência máxima: 18W



PL1663BR

PL1663PT

PL1663DO



PL1662BR

PL1662PT

PL1662DO



PL1662D0 / PL1663D0

Friso

Metal | Acrílico | Branco

LANÇAMENTO • 2023

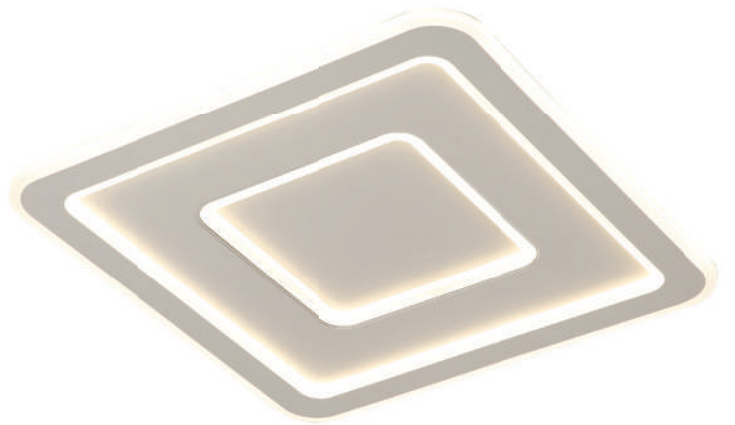

● **PL1760**

Plafon

1XLED | 30W | 1950LM | 3000K
C350XL350XA45mm
Bivolt

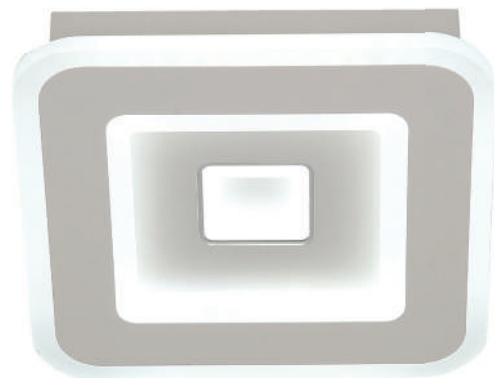
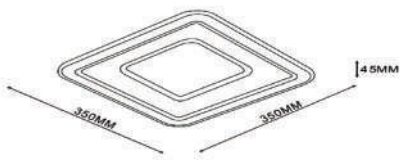

● **PL1759**

Plafon

1XLED | 18W | 998LM | 3000K
C200XL200XA40mm
Bivolt

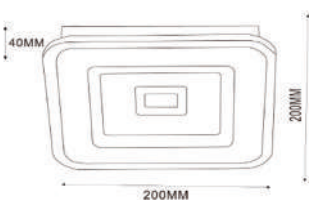

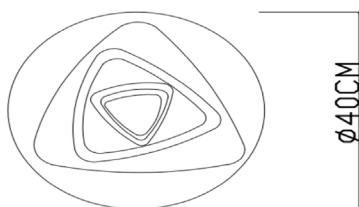

● **PL1761**
Plafon

1XLED | 36W | 2250LM | 3000K
C400XL400XA50mm
Bivolt



PL1761

Passo

Metal | Silicone | Dourado, Preto e Branco

LANÇAMENTO • 2023



● **PL1796**
Plafon

1XLED | 27W | 1620LM | 3000K
D385XA76mm
Bivolt

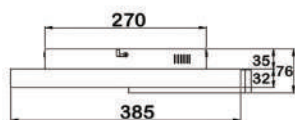



● **PL1797**
Plafon

1XLED | 48W | 2880LM | 3000K
D607XA76mm
Bivolt

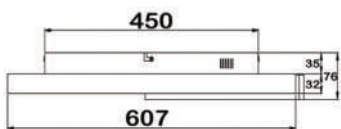

Space

Estrutura: Metal / Plástico

Acabamento: Preto



Cúpula rotativa



● **AR1703**

Arandela

1x G9 Halopin 40W

Dimensões: Ø293 x L95 x A355 mm

Tensão: Bivolt (127V/220V)

Potência máxima: 40W

Possui cabo com interruptor liga e desliga para ser ligado a tomada



● **LM1702**

Luminária de mesa

1x G9 Halopin 40W

Dimensões: Ø305 x L180 x A430 mm

Tensão: Bivolt (127V/220V)

Potência máxima: 40W

Possui cabo com interruptor liga e desliga para ser ligado a tomada



● **CL1704**

Coluna

1x G9 Halopin 40W

Dimensões: Ø325 x L230 x A1400 mm

Tensão: Bivolt (127V/220V)

Potência máxima: 40W

Possui cabo com interruptor liga e desliga para ser ligado a tomada



CL1704



● **PD1705**

Pendente

1x G9 Halopin 40W
Dimensões: Ø230 x L95 x A1500 mm
Tensão: Bivolt (127V/220V)
Potência máxima: 40W
Cabo ajustável até 1500 mm



● **PD1706**

Pendente

6x G9 Halopin 40W
Dimensões: Ø1250 x A1030 mm
Tensão: Bivolt (127V/220V)
Potência máxima: 240W
Cabo ajustável até 1500 mm

Ricci

Estrutura: Metal / Vidro

Difusor: Vidro champagne e transparente

Acabamento: Dourado



Detalhe do vidro



● **PD1616**
Pendente

29x G9 Halopin LED 5W
Dimensões: Ø820 x A760 mm
Tensão: Bivolt (127V/220V)
Potência máxima: 145W
Cabo ajustável até 1500 mm



PD1616



Aura

Estrutura: Metal / Vidro
Difusor: Champagne
Acabamento: Dourado



● **PD1614**
Pendente

15xG9 Halopin LED 5W
Dimensões: Ø900 x A250 mm
Tensão: Bivolt (127V/220V)
Potência máxima: 75W
Cabo ajustável até 1500 mm



● **PD1615**
Pendente

24xG9 Halopin LED 5W
Dimensões: Ø1250 x A250 mm
Tensão: Bivolt (127V/220V)
Potência máxima: 75W
Cabo ajustável até 1500 mm



PD1615

Blasen

Estrutura: Metal/Alumínio/ Vidro

Difusor: Fumê ou Champagne

Acabamento: Preto ou Dourado



Detalhe da iluminação da barra

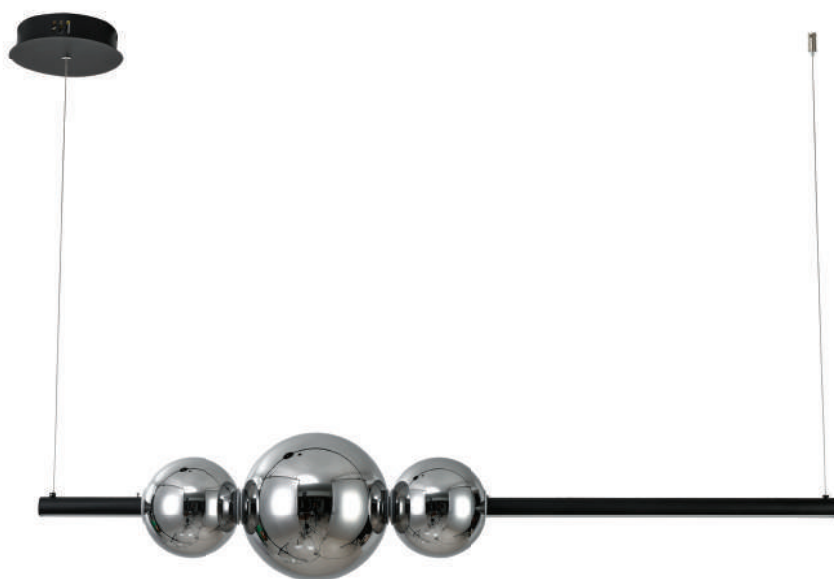

● **PD1725PT**

Pendente

LED 37W

Lúmens: 2300lm

Potência: 3000K

Dimensões: C1200 x L220 x A1650 mm

Tensão: Bivolt (127V/220V)

Potência máxima: 37W

Cabo ajustável até 1500 mm

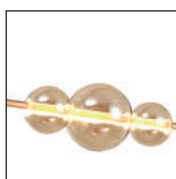

PD1725DO



PD1725PT





PD1725PT

Cosmos

Estrutura: Metal/cúpula de vidro

Difusor: Cúpula champagne /

Cúpula branca

Acabamento: Bronze / Preto



● **PD1430BR**
Pendente

8xG9 Halopin 5W
Dimensões: C900 x L670 x A450 mm
Tensão: Bivolt (127V/220V)
Potência máxima: 40W
Cabo ajustável até 1500 mm

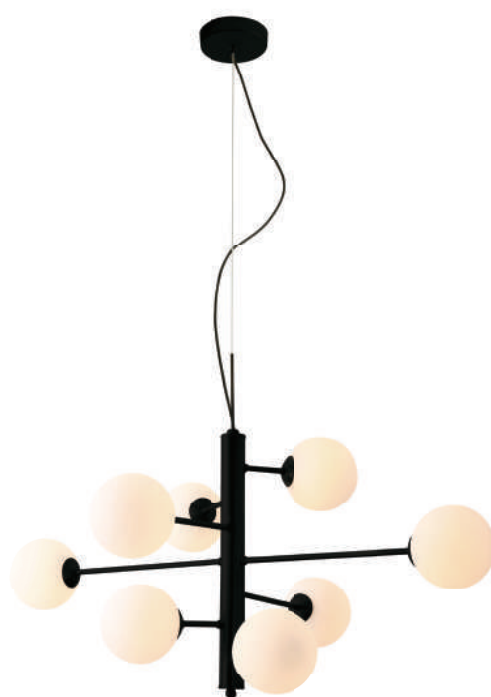

● **PD1430PTBR**
Pendente

8xG9 Halopin 5W
Dimensões: C900 x L670 x A450 mm
Tensão: Bivolt (127V/220V)
Potência máxima: 40W
Cabo ajustável até 1500 mm

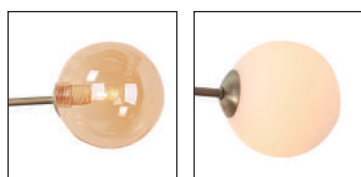

PD1430CH

8 esfera champagne

PD1430BR

8 esfera branco
opalino

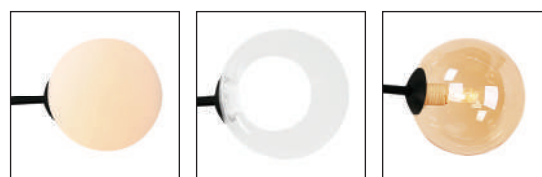

PD1430PTBR

PD1430PTTR

PD1430PTCH



● **PD1431CH**
Pendente

6xG9 Halopin 5W
Dimensões: C1100 x L380 x A380 mm
Tensão: Bivolt (127V/220V)
Potência máxima: 30W
Cabo ajustável até 1500 mm



PD1431CH
6 esfera champagne



PD1431BR
6 esfera branco
opalino

Atomy

Estrutura: Metal/cúpula de vidro

Difusor: Cúpula craquelê /
cúpula branca

Acabamento: Cobre



● **PD1269**
Pendente

12xG9 Halopin (LED) 5W
Dimensões: Ø775 x A370 mm
Tensão: Bivolt (127V/220V)
Potência máxima: 60W
Cabo ajustável até 1500 mm



PD1269
12 cúpulas craquelê



PD1269BR
12 cúpulas brancas
opalinas





PD1269BR

DNA

Estrutura: Metal/cúpula de vidro

Difusor: Cúpula transparente (interno fosco)

Acabamento: Cobre



PD1298



● **PD1298**
Pendente

12xG9 Halopin 5W
Dimensões: C680 x L270 x A330 mm
Tensão: Bivolt (127V/220V)
Potência máxima: 60W
Cabo ajustável até 1500 mm



● **PD1298G**
Pendente

16xG9 Halopin 5W
Dimensões: C800 x L250 x A400 mm
Tensão: Bivolt (127V/220V)
Potência máxima: 80W
Cabo ajustável até 1500 mm

Hunt

Estrutura: Metal/cúpula de vidro
Difusor: Cúpula transparente/cúpula interna fosca
Acabamento: Preto (Detalhes em cobre)



● **AR1264**
Arandela

2xG9 Halopin (LED) 5W
Dimensões: C120 x L270 x A370 mm
Tensão: Bivolt (127V/220V)
Potência máxima: 10W



● **PD1262**
Pendente

8xG9 Halopin 5W
Dimensões: Ø590 x A500 mm
Tensão: Bivolt (127V/220V)
Potência máxima: 40W
Haste ajustável até 760 mm



PD1262

Pinot

Estrutura: Metal/vidro

Difusor: Branco opalino / fumê /
champagne

Acabamento: Preto, branco ou dourado



● **AR1670BR**

Arandela

2x G9 5W

Dimensões: Ø330 x A460 mm

Tensão: Bivolt (127V/220V)

Potência máxima: 10W



AR1670BR

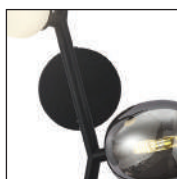

AR1670PT

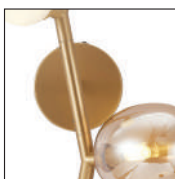

AR1670DO



AR1671DO



● **AR1671DO**
Arandela

4x G9 5W
Dimensões: Ø400 x A950 mm
Tensão: Bivolt (127V/220V)
Potência máxima: 20W

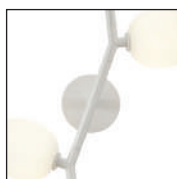

AR1671BR



AR1671PT

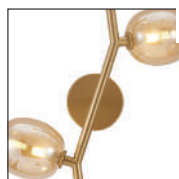

AR1671DO

Pinot

Estrutura: Metal/vidro

Difusor: Branco opalino / fumê /
champagne

Acabamento: Preto, branco ou dourado



● **CL1673DO**

Coluna

7x G9 5W

Dimensões: Ø370 x A1750 mm

Tensão: Bivolt (127V/220V)

Potência máxima: 35W

Possui cabo com interruptor liga e desliga para
ser ligado a tomada



CL1673BR



CL1673PT



CL1673DO

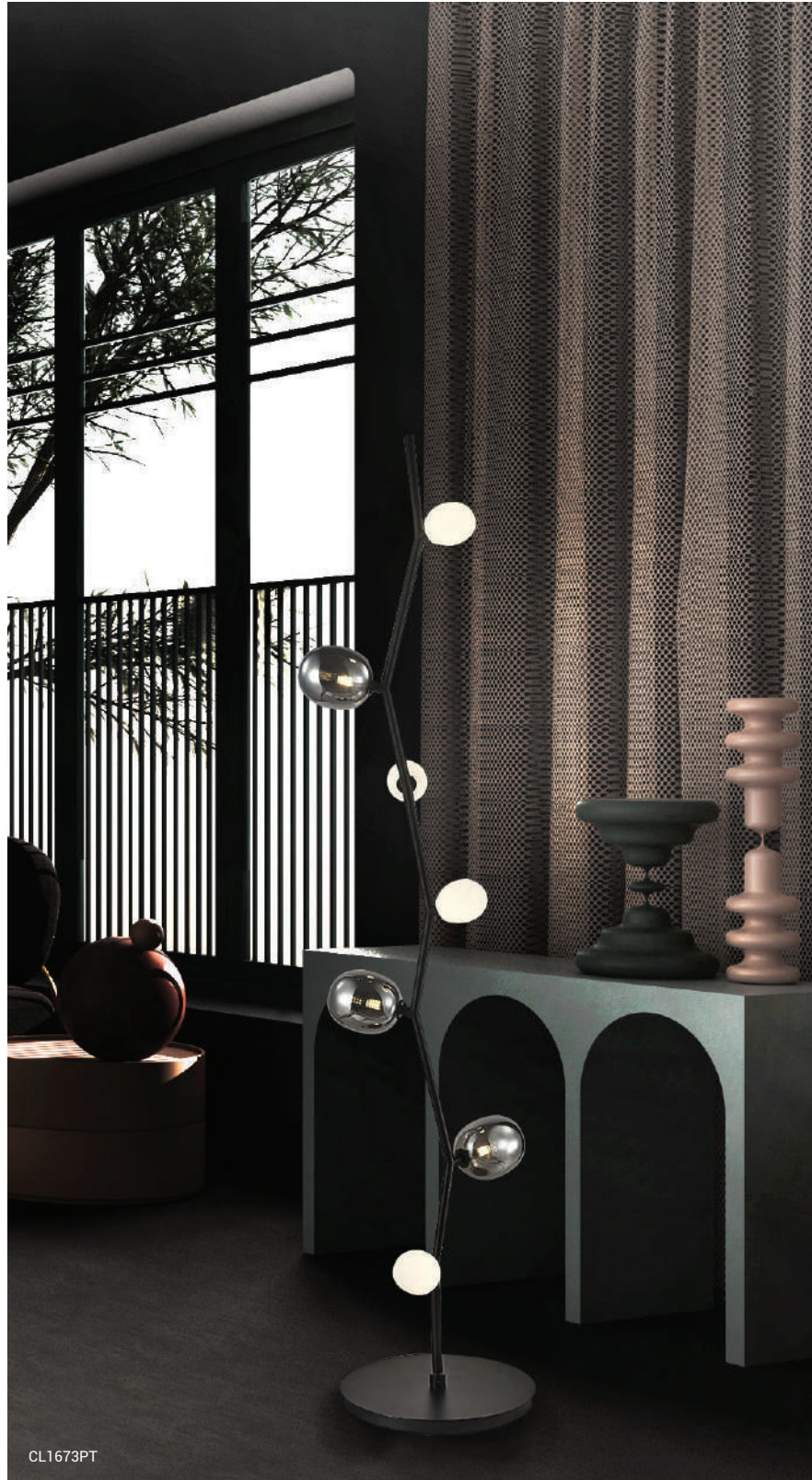

CL1673PT



● **AB1672DO**

Abajur

2x G9 5W

Dimensões: Ø240 x A470 mm

Tensão: Bivolt (127V/220V)

Potência máxima: 10W

Possui cabo com interruptor liga e desliga para ser ligado a tomada



AB1672BR



AB1672PT



AB1672DO

Pinot

Estrutura: Metal/vidro

Difusor: Branco opalino fumê champagne

Acabamento: Preto, branco ou dourado

Duas opções de montagem*



2 Opções de Montagem

● **PD1674PT**
Pendente

5x G9 5W

Dimensões: C1300 x L335 x A400 mm

Tensão: Bivolt (127V/220V)

Potência máxima: 25W

Cabo ajustável até 2000 mm



PD1674BR

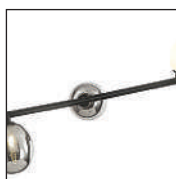

PD1674PT

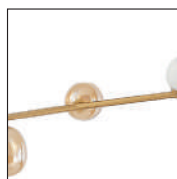

PD1674DO

*Para outra opção de montagem, remova o cabo de aço, mantendo o pendente na vertical



PD1674BR

● **PD1675BR**
Pendente

7x G9 5W
Dimensões: C1750 x L335 x A400 mm
Tensão: Bivolt (127V/220V)
Potência máxima: 35W
Cabo ajustável até 2000 mm



PD1675BR



PD1675PT



PD1675DO

*Para outra opção de montagem, remova o cabo de aço, mantendo o pendente na vertical



2 Opções de Montagem

Neolus

Estrutura: Metal/cúpula de vidro

Difusor: Cúpula Branca

Acabamento: Dourado



● **AR1459**

Arandela

2xG9 (LED) 5W

Dimensões: C230 x L130 x A350 mm

Tensão: Bivolt (127V/220V)

Potência máxima: 10W



● **PD1461**

Pendente

9xG9 5W

Dimensões: Ø920 x A515 mm

Tensão: Bivolt (127V/220V)

Potência máxima: 45W

Haste ajustável até 620 mm



PD1461

Colli

Estrutura: Metal

Difusor: Vidro branco opalino

Acabamento: Dourado ou preto



Pendente e plafon com hastes ajustáveis



● **AR1513DO**

● **AR1513PT**

Arandela

2xG9 5W

Potência máxima: 10W

Dimensões: C120 x A673 mm

Difusor: 2xØ150mm

Tensão: Bivolt (127V/220V)

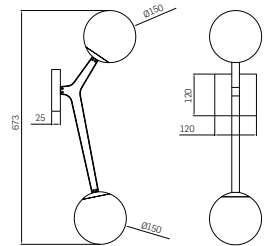

● **PL1609DO**

● **PL1609PT**

Pendente

3xG9 5W

Potência máxima: 15W

Dimensões: L680 x A470 x P560 mm

Tensão: Bivolt (127V/220V)

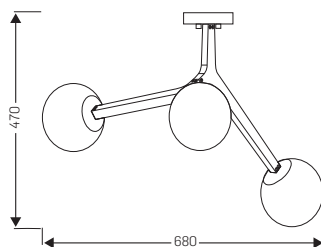



- PD1514DO
- PD1514PT

Pendente

10xG9 5W

Potência máxima: 50W

Dimensões: C1751 x A383 mm

Difusor: 5xØ138 / 5xØ150 mm

Tensão: Bivolt (127V/220V)

Cabo ajustável até 2000 mm

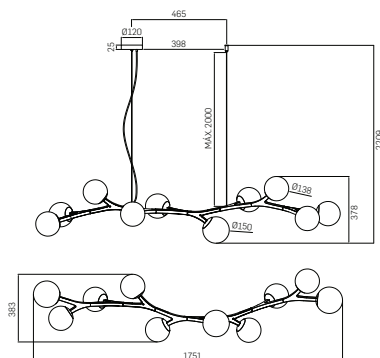



PD1514PT



AR1513DO

Orbit

Estrutura: Alumínio/cúpula de vidro
 Difusor: Opalino, Champagne ou Misto
 (opalino interno e cristal externo)
 Acabamento: Dourado fosco ou preto fosco

- Canopla para instalação em forros de gesso
- Compatível com tampa de caixa de passagem NAC00137 para instalação em lajes (vendida separadamente)

*A dimensão total do produto irá variar de acordo com a esfera utilizada



● **PDH1527PT**
 Pendente

6xG9 Halopin LED 5W
 Dimensões: C1050 x L265 x A160 mm
 Tensão: Bivolt (127V/220V)
 Potência máxima: 30W
 Cabo ajustável até 1500 mm



● **PDH1527DO**
 Pendente

6xG9 Halopin LED 5W
 Dimensões: C1050 x L265 x A160 mm
 Tensão: Bivolt (127V/220V)
 Cabo ajustável até 1500 mm



PDH1527PT
 2 esferas de 10cm e
 4 esferas de 12cm

PDH1527TRPT
 *6 esferas de 12cm

PDH1527CHPT
 2 esferas de 10cm e
 4 esferas de 12cm

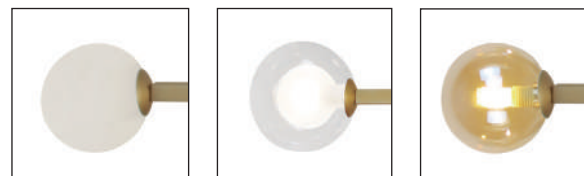

PDH1527DO
 2 esferas de 10cm e
 4 esferas de 12cm

PDH1527TRDO
 *6 esferas de 12cm

PDH1527CHDO
 2 esferas de 10cm e
 4 esferas de 12cm



PDH1576DO



● **PDH1576CHDO**

Pendente

8xG9 Halopin LED 5W
 Dimensões: C1450 x L265 x A170 mm
 Tensão: Bivolt (127V/220V)
 Potência máxima: 40W
 Cabo ajustável até 1500 mm



● **PDH1576PT**

Pendente

8xG9 Halopin LED 5W
 Dimensões: C1450 x L265 x A170 mm
 Tensão: Bivolt (127V/220V)
 Potência máxima: 40W
 Cabo ajustável até 1500 mm



PDH1576DO
8 esferas de 12cm



PDH1576TRDO
8 esferas de 12cm



PDH1576CHDO
8 esferas de 12cm

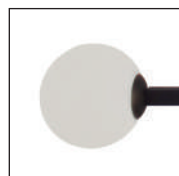

PDH1576PT
8 esferas de 12cm



PDH1576TRPT
8 esferas de 12cm



PDH1576CHPT
8 esferas de 12cm

Orbit

Estrutura: Alumínio/cúpula de vidro
 Difusor: Opalino, Champagne ou Misto
 (opalino interno e cristal externo)
 Acabamento: Dourado fosco ou preto fosco

Canopla compatível com instalação em lajes
 (caixa de passagem)

***A dimensão total do produto irá variar de acordo com a esfera utilizada**

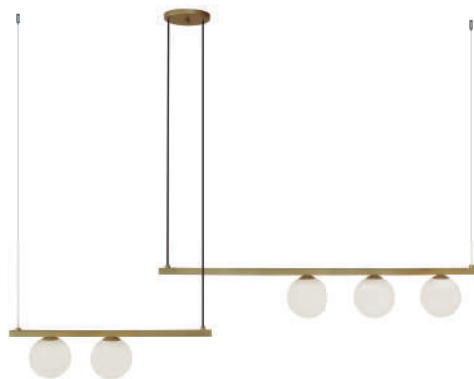

● PDH1528PT

Pendente

5xG9 Halopin LED 5W
 Dimensões: C1185 x L120 x A140 mm
 Tensão: Bivolt (127V/220V)
 Potência máxima: 25W
 Cabo ajustável até 1500 mm

● PDH1528DO

Pendente

5xG9 Halopin LED 5W
 Dimensões: C1185 x L120 x A140 mm
 Tensão: Bivolt (127V/220V)
 Potência máxima: 25W
 Cabo ajustável até 1500 mm



PDH1528PT

*5 esferas de 10cm

PDH1528TRPT

5 esferas de 12cm

PDH1528CHPT

5 esferas de 10cm



PDH1528DO

*5 esferas de 10cm

PDH1528TRDO

5 esferas de 12cm

PDH1528CHDO

5 esferas de 10cm



PDH1528TRDO

Orbit

Estrutura: Alumínio/cúpula de vidro
 Difusor: Opalino, Champagne ou Misto
 (opalino interno e cristal externo)
 Acabamento: Dourado fosco ou preto fosco

.....
 Ideal para instalação em paredes drywall



ARH1535TRDO



● **ARH1535PT**

Arandela

2xG9 Halopin LED 5W
 Dimensões: C160 x L120 x A400 mm
 Tensão: Bivolt (127V/220V)
 Potência máxima: 10W

● **ARH1535DO**

Arandela

2xG9 Halopin LED 5W
 Dimensões: C160 x L120 x A400 mm
 Tensão: Bivolt (127V/220V)
 Potência máxima: 10W



ARH1535PT

1 esfera de 10cm e
 1 esfera de 12cm

ARH1535TRPT

1 esfera de 8cm e
 1 esfera de 12cm

ARH1535CHPT

1 esfera de 10cm e
 1 esfera de 12cm



ARH1535DO

1 esfera de 10cm e
 1 esfera de 12cm

ARH1535TRDO

1 esfera de 8cm e
 1 esfera de 12cm

ARH1535CHDO

1 esfera de 10cm e
 1 esfera de 12cm



ARH1535PT

Orbit

Estrutura: Alumínio/cúpula de vidro
 Difusor: Opalino, Champagne ou Misto
 (opalino interno e cristal externo)
 Acabamento: Dourado fosco ou preto fosco

Canopla compacta exclusiva para forros de gesso



● **PDH1530PT**
 Pendente

4xG9 Halopin LED 5W
 Dimensões: C260 x L200 x A4750 mm
 Tensão: Bivolt (127V/220V)
 Potência máxima: 20W
 Cabo ajustável até 1500 mm

● **PDH1530DO**
 Pendente

4xG9 Halopin LED 5W
 Dimensões: C260 x L200 x A4750 mm
 Tensão: Bivolt (127V/220V)
 Potência máxima: 20W
 Cabo ajustável até 1500 mm

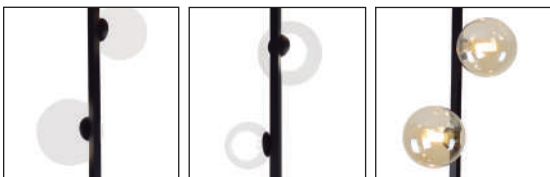

PDH1530PT
 2 esferas de 8cm,
 1 esfera de 10cm e
 esfera de 12cm

PDH1530TRPT
 2 esferas de 8cm e
 2 esferas de 12cm

PDH1530CHPT
 2 esferas de 10cm e
 2 esferas de 12cm

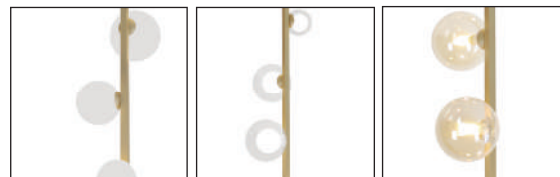

PDH1530DO
 2 esferas de 8cm,
 1 esfera de 10cm e
 esfera de 12cm

PDH1530TRDO
 2 esferas de 8cm e
 2 esferas de 12cm

PDH1530CHDO
 2 esferas de 10cm e
 2 esferas de 12cm



PDH1530TRPT

Orbit

Estrutura: Alumínio/cúpula de vidro
 Difusor: Opalino, Champagne ou Misto
 (opalino interno e cristal externo)
 Acabamento: Dourado fosco ou preto fosco

- Canopla para instalação em forros de gesso
- Compatível com tampa de caixa de passagem NAC00137 para instalação em lajes (vendida separadamente)

***A dimensão total do produto irá variar de acordo com a esfera utilizada**



PDH1532DO



● **PDH1532PT**
 Pendente

1xG9 Halopin LED 5W
 Dimensões: C180 x L100 x A280 mm
 Tensão: Bivolt (127V/220V)
 Potência máxima: 5W
 Cabo ajustável até 1500 mm



● **PDH1532CHDO**
 Pendente

1xG9 Halopin LED 5W
 Dimensões: C180 x L100 x A280 mm
 Tensão: Bivolt (127V/220V)
 Potência máxima: 5W
 Cabo ajustável até 1500 mm



PDH1532PT
 1 esfera de 10cm

PDH1532TRPT
 *1 esfera de 12cm

PDH1532CHPT
 1 esfera de 10cm

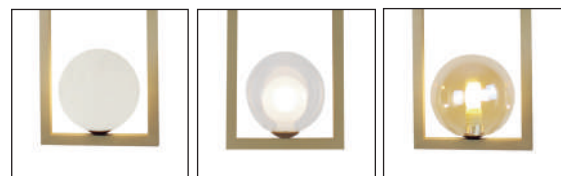

PDH1532DO
 1 esfera de 10cm

PDH1532TRDO
 *1 esfera de 12cm

PDH1532CHDO
 1 esfera de 10cm



● **PDH1533PT**

Pendente

2xG9 Halopin LED 5W
 Dimensões: C260 x L120 x A260 mm
 Tensão: Bivolt (127V/220V)
 Potência máxima: 10W
 Cabo ajustável até 1500 mm



PDH1533TRPT



● **PDH1533DO**

Pendente

2xG9 Halopin LED 5W
 Dimensões: C260 x L120 x A260 mm
 Tensão: Bivolt (127V/220V)
 Potência máxima: 10W
 Cabo ajustável até 1500 mm



PDH1533PT
 1 esfera de 10cm e
 esfera de 12cm

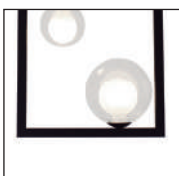

PDH1533TRPT
 1 esfera de 8cm e
 esfera de 12cm



PDH1533CHPT
 1 esfera de 10cm e
 esfera de 12cm

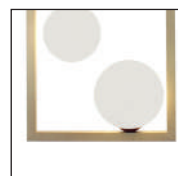

PDH1533DO
 1 esfera de 10cm e
 esfera de 12cm

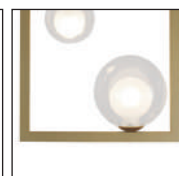

PDH1533TRDO
 1 esfera de 8cm e
 esfera de 12cm



PDH1533CHDO
 1 esfera de 10cm e
 esfera de 12cm

Orbit II

Estrutura: Alumínio/cúpula de vidro
 Difusor: Opalino, Champagne ou Misto
 (opalino interno e cristal externo)
 Acabamento: Dourado fosco ou preto fosco

- Canopla para instalação em forros de gesso
- Compatível com tampa de caixa de passagem NAC00137 para instalação em lajes (vendida separadamente)

*A dimensão total do produto irá variar de acordo com a esfera utilizada



● **PDH1552TRPT**
 Pendente

1xG9 Halopin LED 5W
 Dimensões: C100 x L100 x A250 mm
 Tensão: Bivolt (127V/220V)
 Potência máxima: 5W
 Cabo ajustável até 1500 mm



● **PDH1552DO**
 Pendente

1xG9 Halopin LED 5W
 Dimensões: C100 x L100 x A250 mm
 Tensão: Bivolt (127V/220V)
 Potência máxima: 5W
 Cabo ajustável até 1500 mm



PDH1552PT 1 esfera de 10cm
PDH1552TRPT *1 esfera de 12cm
PDH1552CHPT 1 esfera de 10cm



PDH1552DO 1 esfera de 10cm
PDH1552TRDO *1 esfera de 12cm
PDH1552CHDO 1 esfera de 10cm



PDH1552DO

Orbit II

Estrutura: Alumínio/cúpula de vidro
 Difusor: Opalino, Champagne ou Misto
 (opalino interno e cristal externo)
 Acabamento: Dourado fosco ou preto
 fosco

- Canopla para instalação em forros de gesso
- Compatível com tampa de caixa de passagem NAC00137 para instalação em lajes (vendida separadamente)

*A dimensão total do produto irá variar de acordo com a esfera utilizada



● **PDH1553CHDO**
 Pendente

2xG9 Halopin LED 5W
 Dimensões: C280 x L100 x A250 mm
 Tensão: Bivolt (127V/220V)
 Potência máxima: 10W
 Cabo ajustável até 1500 mm

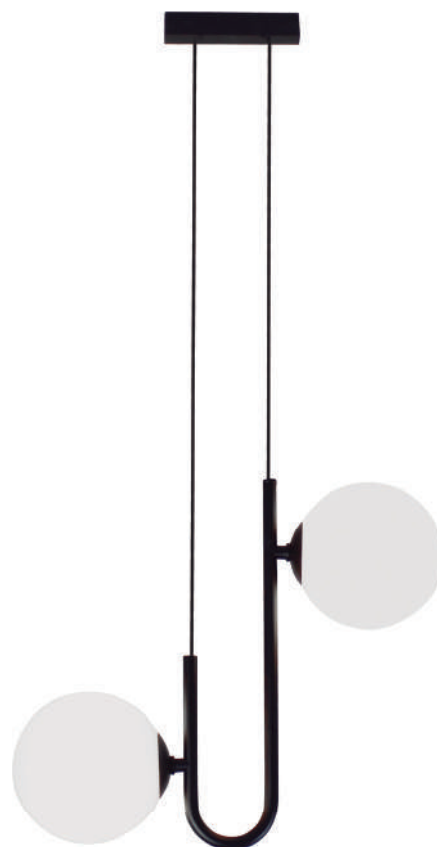

● **PDH1553PT**
 Pendente

2xG9 Halopin LED 5W
 Dimensões: C280 x L100 x A250 mm
 Tensão: Bivolt (127V/220V)
 Potência máxima: 10W
 Cabo ajustável até 1500 mm



PDH1553PT

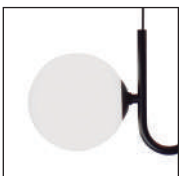

PDH1553PT
2 esferas de 10cm



PDH1553TRPT
*2 esferas de 12cm



PDH1553CHPT
2 esferas de 10cm



PDH1553DO
2 esferas de 10cm

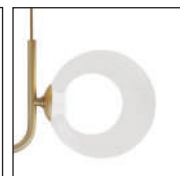

PDH1553TRDO
*2 esferas de 12cm



PDH1553CHDO
2 esferas de 10cm

Orbit II

Estrutura: Alumínio/cúpula de vidro
 Difusor: Opalino, Champagne ou Misto
 (opalino interno e cristal externo)
 Acabamento: Dourado fosco ou preto fosco

Canopla compacta exclusiva para
 forros de gesso



● **PDH1559PT**
 Pendente

1xG9 Halopin LED 5W
 Dimensões: C120 x L120 x A320 mm
 Tensão: Bivolt (127V/220V)
 Potência máxima: 5W
 Cabo ajustável até 1500 mm

● **PDH1559DO**
 Pendente

1xG9 Halopin LED 5W
 Dimensões: C120 x L120 x A320 mm
 Tensão: Bivolt (127V/220V)
 Potência máxima: 5W
 Cabo ajustável até 1500 mm



PDH1559PT 1 esfera de 12cm
PDH1559TRPT 1 esfera de 12cm
PDH1559CHPT 1 esfera de 12cm



PDH1559DO 1 esfera de 12cm
PDH1559TRDO 1 esfera de 12cm
PDH1559CHDO 1 esfera de 12cm



PDH1559PT

Orbit II

Estrutura: Alumínio/cúpula de vidro
 Difusor: Opalino, Champagne ou Misto
 (opalino interno e cristal externo)
 Acabamento: Dourado fosco ou preto
 fosco

*A dimensão total do produto irá variar de
 acordo com a esfera utilizada



ARH1536DO



● **ARH1536PT**
 Arandela

1xG9 Halopin LED 5W
 Dimensões: C140 x L110 x A300 mm
 Tensão: Bivolt (127V/220V)
 Potência máxima: 5W



● **ARH1536DO**
 Arandela

1xG9 Halopin LED 5W
 Dimensões: C140 x L110 x A300 mm
 Tensão: Bivolt (127V/220V)
 Potência máxima: 5W



ARH1536PT 1 esfera de 10cm
ARH1536TRPT *1 esfera de 12cm
ARH1536CHPT 1 esfera de 10cm



ARH1536DO 1 esfera de 10cm
ARH1536TRDO *1 esfera de 12cm
ARH1536CHDO 1 esfera de 10cm



Canopla compacta exclusiva para forros de gesso



● **PDH1539PT**

Pendente

4xG9 Halopin LED 5W
 Dimensões: C900 x L100 x A230 mm
 Tensão: Bivolt (127V/220V)
 Potência máxima: 20W
 Cabo ajustável até 1500 mm



PDH1539PT



● **PDH1539DO**

Pendente

4xG9 Halopin LED 5W
 Dimensões: C900 x L100 x A230 mm
 Tensão: Bivolt (127V/220V)
 Potência máxima: 20W
 Cabo ajustável até 1500 mm



PDH1539PT

*2 esferas de 10cm e
2 esferas de 12cm



PDH1539TRPT

2 esferas de 12cm



PDH1539CHPT

2 esferas de 10cm e
2 esferas de 12cm

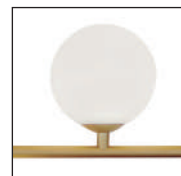

PDH1539DO

*2 esferas de 10cm e
2 esferas de 12cm

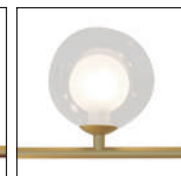

PDH1539TRDO

2 esferas de 12cm



PDH1539CHDO

2 esferas de 10cm e
2 esferas de 12cm

Orbit II

Estrutura: Alumínio/cúpula de vidro
 Difusor: Opalino, Champagne ou Misto
 (opalino interno e cristal externo)
 Acabamento: Dourado fosco ou preto fosco

Canopla compacta exclusiva para forros de gesso

***A dimensão total do produto irá variar de acordo com a esfera utilizada**



● **PDH1534PT**
 Pendente

1xG9 Halopin LED 5W
 Dimensões: C100 x L100 x A235 mm
 Tensão: Bivolt (127V/220V)
 Potência máxima: 5W
 Cabo ajustável até 1500 mm

● **PDH1534CHDO**
 Pendente

1xG9 Halopin LED 5W
 Dimensões: C100 x L100 x A235 mm
 Tensão: Bivolt (127V/220V)
 Potência máxima: 5W
 Cabo ajustável até 1500 mm



PDH1534PT 1 esfera de 10cm
PDH1534TRPT *1 esfera de 12cm
PDH1534CHPT 1 esfera de 10cm



PDH1534DO 1 esfera de 10cm
PDH1534TRDO *1 esfera de 12cm
PDH1534CHDO 1 esfera de 10cm



PDH1534TRPT

Hook

Estrutura: Alumínio/cúpula de vidro
 Difusor: Opalino, Champagne ou Misto
 (opalino interno e cristal externo)
 Acabamento: Dourado ou preto fosco

***A dimensão total do produto irá variar de acordo com a esfera utilizada**



● **ARH1560PT**

Arandela

1xG9 Halopin LED 5W
 Dimensões: C130 x L100 x A180 mm
 Tensão: Bivolt (127V/220V)
 Potência máxima: 5W
 Cabo com 1500 mm com interruptor liga e desliga para ser ligado a tomada

● **ARH1560DO**

Arandela

1xG9 Halopin LED 5W
 Dimensões: C130 x L100 x A180 mm
 Tensão: Bivolt (127V/220V)
 Potência máxima: 5W
 Cabo com 1500 mm com interruptor liga e desliga para ser ligado a tomada



ARH1560PT

*1 esfera de 10cm



ARH1560TRPT

1 esfera de 12cm



ARH1560CHPT

1 esfera de 10cm



ARH1560DO

*1 esfera de 10cm



ARH1560TRDO

1 esfera de 12cm



ARH1560CHDO

1 esfera de 10cm



ARH1560PT

Spy

Estrutura: Metal/vidro

Difusor: Difusor branco opalino

Acabamento: Preto ou dourado

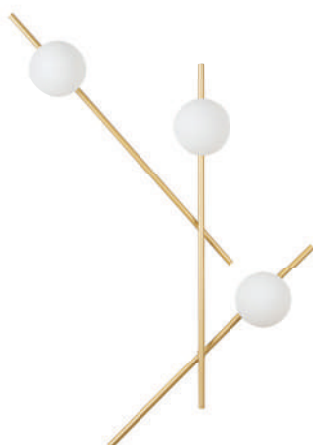

● **AR1726DO**
Arandela/Plafon

3x G9 5W
Dimensões: C815 x L635 x P150 mm
Tensão: Bivolt (127V/220V)
Potência máxima: 15W

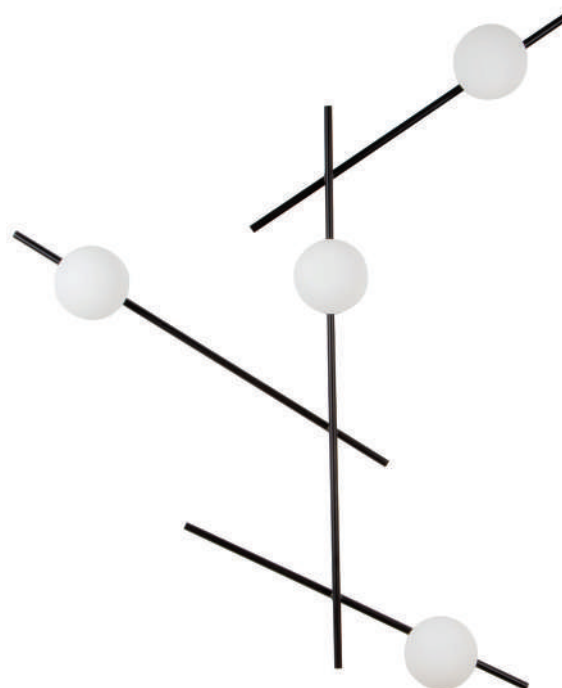

● **AR1727PT**
Arandela/Plafon

4x G9 5W
Dimensões: C920 x L780 x P150 mm
Tensão: Bivolt (127V/220V)
Potência máxima: 20W

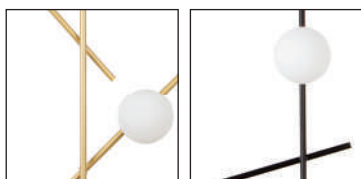

AR1726DO

AR1726PT

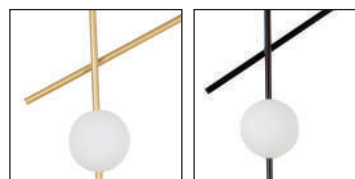

AR1727DO

AR1727PT

Produto flexível na instalação



AR1727DO

Orbit Mondri

Estrutura: Alumínio/cúpula de vidro
 Difusor: Opalino, Champagne ou Misto
 (opalino interno e cristal externo)
 Acabamento: Dourado fosco ou preto fosco

Canopla de 10cm (recomendado para
 instalação em tetos/paredes de gesso)



● **PLH1593PT**

Plafon/Arandela

1x G9 Halopin LED 5W
 Dimensões: C300 x L300 x A145 mm
 Tensão: Bivolt (127V/220V)
 Potência máxima: 5W

● **PLH1593TRDO**

Plafon/Arandela

1x G9 Halopin LED 5W
 Dimensões: C300 x L300 x A145 mm
 Tensão: Bivolt (127V/220V)
 Potência máxima: 5W



PLH1593PT
1 esfera de 12cm

PLH1593TRPT
1 esfera de 12cm

PLH1593CHPT
1 esfera de 12cm

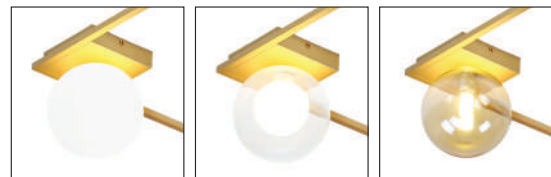

PLH1593DO
1 esfera de 12cm

PLH1593TRDO
1 esfera de 12cm

PLH1593CHDO
1 esfera de 12cm



PLH1594FT

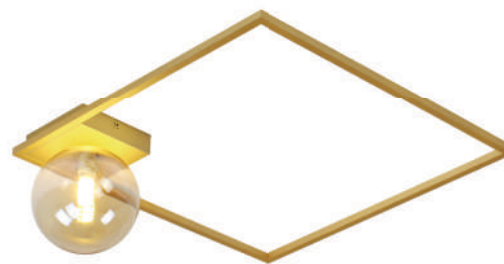
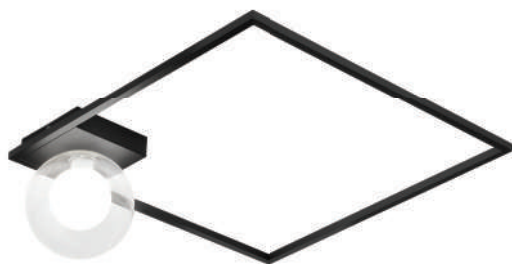

● **PLH1594TRPT**

Plafon/Arandela

1x G9 Halopin LED 5W
 Dimensões: C400 x L400 x A145 mm
 Tensão: Bivolt (127V/220V)
 Potência máxima: 5W

● **PLH1594CHDO**

Plafon/Arandela

1x G9 Halopin LED 5W
 Dimensões: C400 x L400 x A145 mm
 Tensão: Bivolt (127V/220V)
 Potência máxima: 5W



PLH1594PT
1 esfera de 12cm

PLH1594TRPT
1 esfera de 12cm

PLH1594CHPT
1 esfera de 12cm

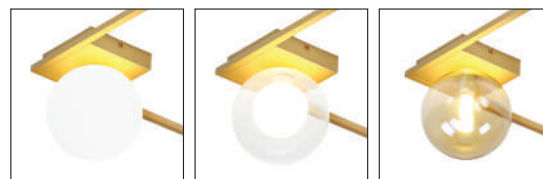

PLH1594DO
1 esfera de 12cm

PLH1594TRDO
1 esfera de 12cm

PLH1594CHDO
1 esfera de 12cm

Orbit Mondri

Estrutura: Alumínio/cúpula de vidro
 Difusor: Opalino, Champagne ou Misto
 (opalino interno e cristal externo)
 Acabamento: Dourado fosco ou preto
 fosco

- Canopla de 10cm (recomendado para instalação em tetos/paredes de gesso)
- Pode ser utilizado como plafon ou arandela
- Necessária ligação elétrica em todas as bases
- Acompanha 1 canopla para montagem de produtos sobrepostos

*A dimensão total da composição irá variar de acordo com a instalação

KIT COM 2 PEÇAS PARA MONTAGEM MODULAR

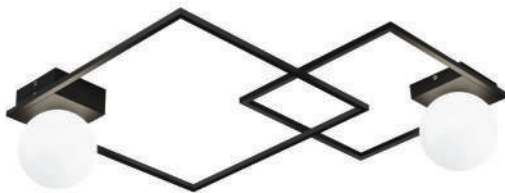
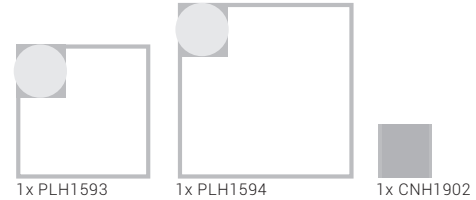

● PLH1595PT Plafon/Arandela

2x G9 Halopin LED 5W
 Dimensões: * 1xPLH1593 C300 x L300 x A145 mm
 + 1xPLH1594 C400 x L400 x A145 mm
 Tensão: Bivolt (127V/220V)
 Potência máxima: 10W

● PLH1595TRDO Plafon/Arandela

2x G9 Halopin LED 5W
 Dimensões: * 1xPLH1593 C300 x L300 x A145 mm
 + 1xPLH1594 C400 x L400 x A145mm
 Tensão: Bivolt (127V/220V)
 Potência máxima: 10W

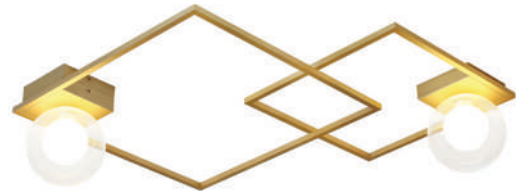

PLH1595PT 2 esferas de 12cm
PLH1595TRPT 2 esferas de 12cm
PLH1595CHPT 2 esferas de 12cm

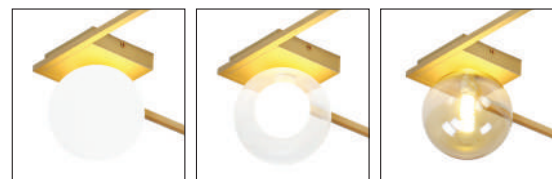

PLH1595DO 2 esferas de 12cm
PLH1595TRDO 2 esferas de 12cm
PLH1595CHDO 2 esferas de 12cm

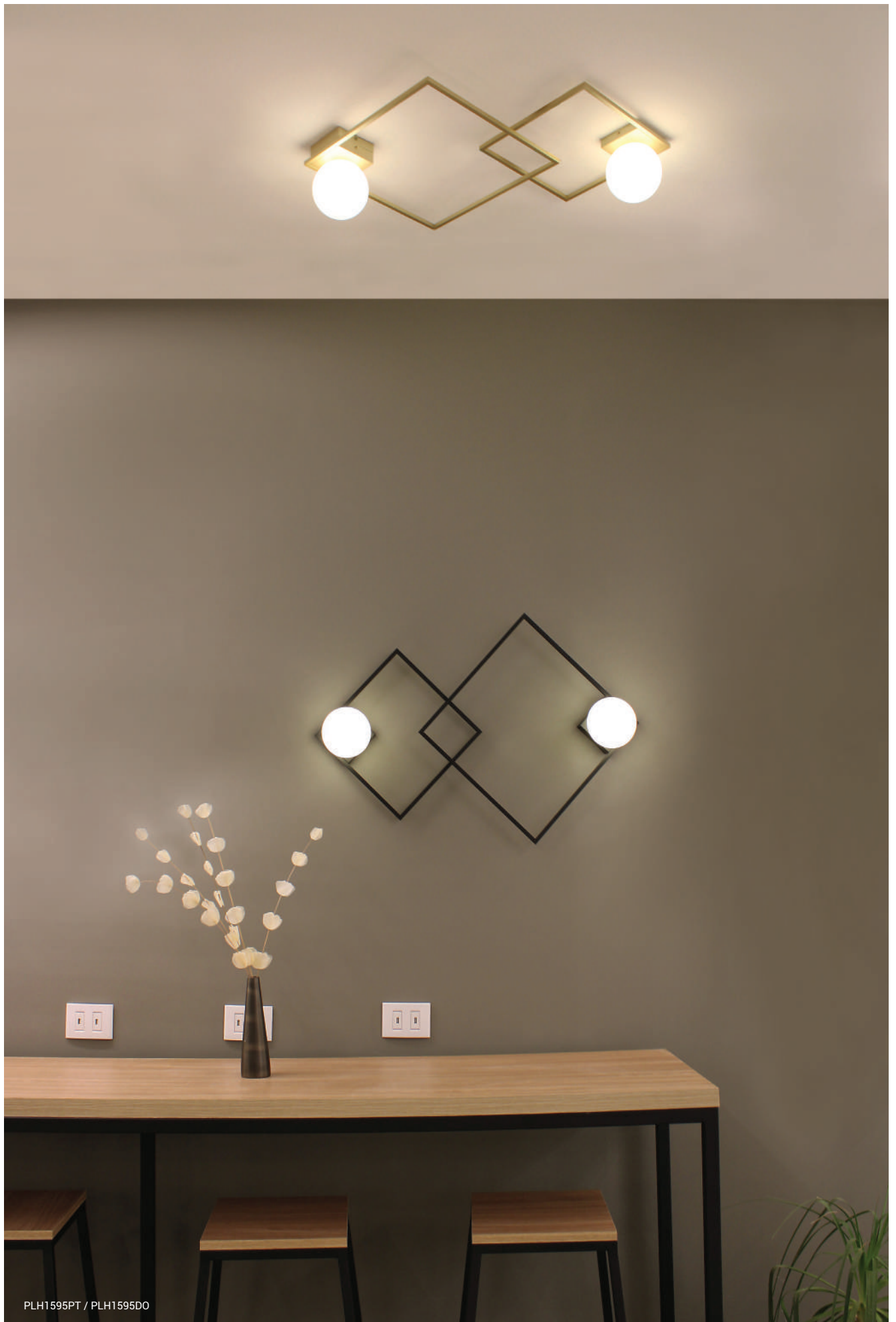

PLH1595PT / PLH1595DO

Orbit Mondri

Estrutura: Alumínio/cúpula de vidro
 Difusor: Opalino, Champagne ou Misto
 (opalino interno e cristal externo)
 Acabamento: Dourado fosco ou preto fosco

- Canopla de 10cm (recomendado para instalação em tetos/paredes de gesso)
- Pode ser utilizado como plafon ou arandela



● PLH1596TRPT

Plafon/Arandela

1x G9 Halopin LED 5W
 Dimensões: C500 x L120 x A145 mm
 Tensão: Bivolt (127V/220V)
 Potência máxima: 5W

● PLH1596CHDO

Plafon/Arandela

1x G9 Halopin LED 5W
 Dimensões: C500 x L120 x A145 mm
 Tensão: Bivolt (127V/220V)
 Potência máxima: 5W



PLH1596PT
1 esfera de 12cm

PLH1596TRPT
1 esfera de 12cm

PLH1596CHPT
1 esfera de 12cm



PLH1596DO
1 esfera de 12cm

PLH1596TRDO
1 esfera de 12cm

PLH1596CHDO
1 esfera de 12cm



PLH1596PT



● **PLH1597CHPT**

Plafon/Arandela

1x G9 Halopin LED 5W
 Dimensões: C600 x L120 x A145 mm
 Tensão: Bivolt (127V/220V)
 Potência máxima: 5W

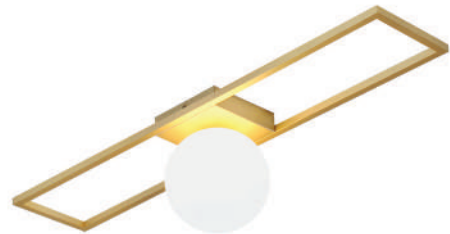

● **PLH1597DO**

Plafon/Arandela

1x G9 Halopin LED 5W
 Dimensões: C600 x L120 x A145 mm
 Tensão: Bivolt (127V/220V)
 Potência máxima: 5W



PLH1597PT
1 esfera de 12cm

PLH1597TRPT
1 esfera de 12cm

PLH1597CHPT
1 esfera de 12cm

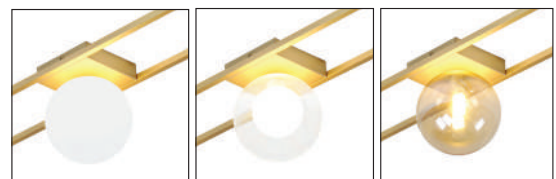

PLH1597DO
1 esfera de 12cm

PLH1597TRDO
1 esfera de 12cm

PLH1597CHDO
1 esfera de 12cm

Orbit Mondri

Estrutura: Alumínio/cúpula de vidro
 Difusor: Opalino, Champagne ou Misto
 (opalino interno e cristal externo)
 Acabamento: Dourado fosco ou preto fosco

- Canopla de 10cm (recomendado para instalação em tetos/paredes de gesso)
- Pode ser utilizado como plafon ou arandela
- Necessária ligação elétrica em todas as bases
- Acompanha 1 canopla para montagem de produtos sobrepostos

*A dimensão total da composição irá variar de acordo com a instalação

KIT COM 2 PEÇAS PARA MONTAGEM MODULAR

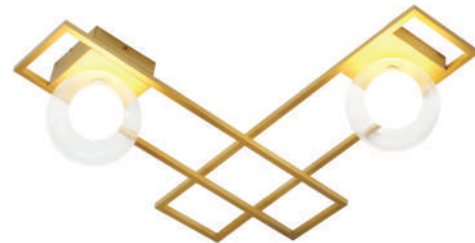
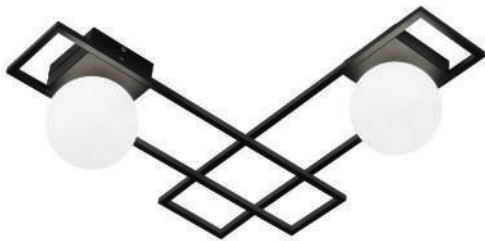
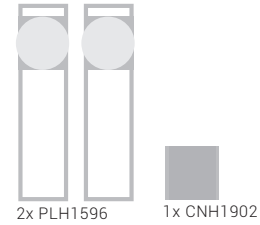

● PLH1598PT Plafon/Arandela

2x G9 Halopin LED 5W
 Dimensões: * 2xPLH1596 C500 x L120 x A145 mm
 Tensão: Bivolt (127V/220V)
 Potência máxima: 10W

● PLH1598TRDO Plafon/Arandela

2x G9 Halopin LED 5W
 Dimensões: * 2xPLH1596 C500 x L120 x A145 mm
 Tensão: Bivolt (127V/220V)
 Potência máxima: 10W



PLH1598PT 2 esferas de 12cm
PLH1598TRPT 2 esferas de 12cm
PLH1598CHPT 2 esferas de 12cm



PLH1598DO 2 esferas de 12cm
PLH1598TRDO 2 esferas de 12cm
PLH1598CHDO 2 esferas de 12cm



PLH1598PT

Orbit Mondri

Estrutura: Alumínio/cúpula de vidro
 Difusor: Opalino, Champagne ou Misto
 (opalino interno e cristal externo)
 Acabamento: Dourado fosco ou preto fosco

- Canopla de 10cm (recomendado para instalação em tetos/paredes de gesso)
- Pode ser utilizado como plafon ou arandela
- Necessária ligação elétrica em todas as bases
- Acompanha 1 canopla para montagem de produtos sobrepostos

*A dimensão total da composição irá variar de acordo com a instalação

KIT COM 3 PEÇAS PARA MONTAGEM MODULAR

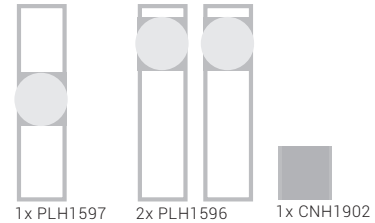

● PLH1905TRPT

Plafon/Arandela

3x G9 Halopin LED 5W
 Dimensões: * 2xPLH1596 C500 x L120 x A145 mm
 + 1xPLH1597 C600 x L120 x A145 mm
 Tensão: Bivolt (127V/220V)
 Potência máxima: 15W

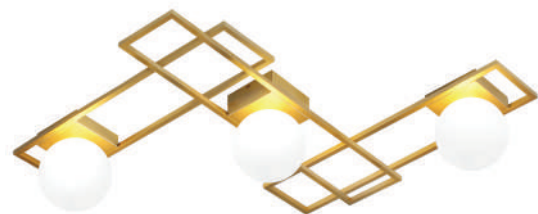

● PLH1905DO

Plafon/Arandela

3x G9 Halopin LED 5W
 Dimensões: * 2xPLH1596 C500 x L120 x A145 mm
 + 1xPLH1597 C600 x L120 x A145 mm
 Tensão: Bivolt (127V/220V)
 Potência máxima: 15W



PLH1905PT
3 esferas de 12cm

PLH1905TRPT
3 esferas de 12cm

PLH1905CHPT
3 esferas de 12cm



PLH1905DO
3 esferas de 12cm

PLH1905TRDO
3 esferas de 12cm

PLH1905CHDO
3 esferas de 12cm

CANOPLA PARA MONTAGEM DE CONJUNTOS

Necessário quando é realizada a montagem de composições de peças sobrepostas com utilização de produtos vendidos individualmente (item já incluso nos kits de montagens vendidos com duas ou mais peças)

- Produzido em alumínio
- Acabamentos dourado ou preto



CNH1902PT

Material: Estrutura em alumínio
Cor: Preta
Dimensões: C10 x L10 x A3,8cm



CNH1902DO

Material: Estrutura em alumínio
Cor: Dourada
Dimensões: C10 x L10 x A3,8cm

Orbit Mondri

Estrutura: Alumínio/cúpula de vidro
 Difusor: Opalino, Champagne ou Misto
 (opalino interno e cristal externo)
 Acabamento: Dourado fosco ou preto fosco

- Canopla de 10cm (recomendado para instalação em tetos/paredes de gesso)
- Pode ser utilizado como plafon ou arandela



● ARH1599PT

Plafon/Arandela

1x G9 Halopin LED 5W
 Dimensões: C130 x L120 x A130 mm
 Tensão: Bivolt (127V/220V)
 Potência máxima: 5W

● ARH1599DO

Plafon/Arandela

1x G9 Halopin LED 5W
 Dimensões: C130 x L120 x A130 mm
 Tensão: Bivolt (127V/220V)
 Potência máxima: 5W



ARH1599PT
1 esfera de 12cm

ARH1599TRPT
1 esfera de 12cm

ARH1599CHPT
1 esfera de 12cm



ARH1599DO
1 esfera de 12cm

ARH1599TRDO
1 esfera de 12cm

ARH1599CHDO
1 esfera de 12cm



ARH1599DO

Cloud II

Estrutura: Metal / Vidro

Difusor: Difusor ambar / difusor interno
branco opalino

Acabamento: Dourado



● **PD1682DO**

Pendente

1xG9 40W

Dimensões: Ø300 x A315 mm

Tensão: Bivolt (127V/220V)

Potência máxima: 40W

Cabo ajustável até 1500 mm

● **PD1683DO**

Pendente

1xG9 40W

Dimensões: Ø450 x A435 mm

Tensão: Bivolt (127V/220V)

Potência máxima: 40W

Cabo ajustável até 1500 mm



PD1682DO / PD1683DO

Cloud

Estrutura: Metal e vidro
 Difusor: Vidro opalino
 Acabamento: Dourado ou preto
 Cabo ajustável até 1,50 m

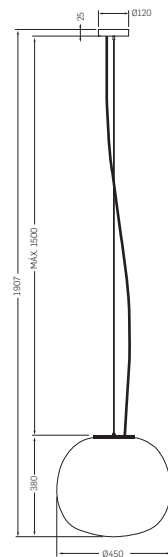
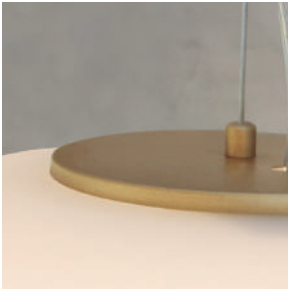

● PD1497DO
 ● PD1497PT
 Pendente

1xE27 / 40W
 Dim.: Ø450 x A380 mm
 Tensão: Bivolt (127V/220V)
 Potência máx.: 40W
 Cabo ajustável até 1500 mm

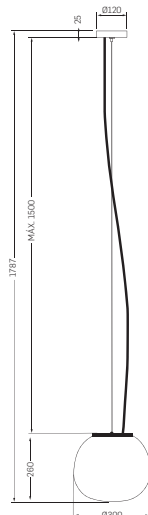

● PD1496DO
 ● PD1496PT
 Pendente

1xE27 / 40W
 Dimensões: Ø300 x A260 mm
 Tensão: Bivolt (127V/220V)
 Potência máx.: 40W
 Cabo ajustável até 1500 mm



PD1497DO

Muvuca

Metal | Vidro | Dourado e Branco

LANÇAMENTO • 2023

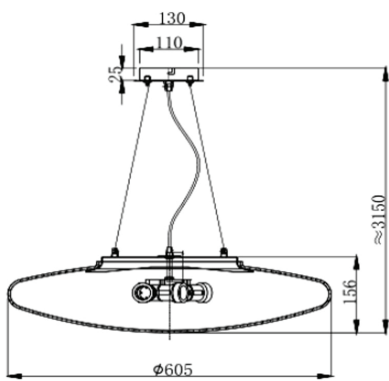

Cabo ajustável até 3000mm

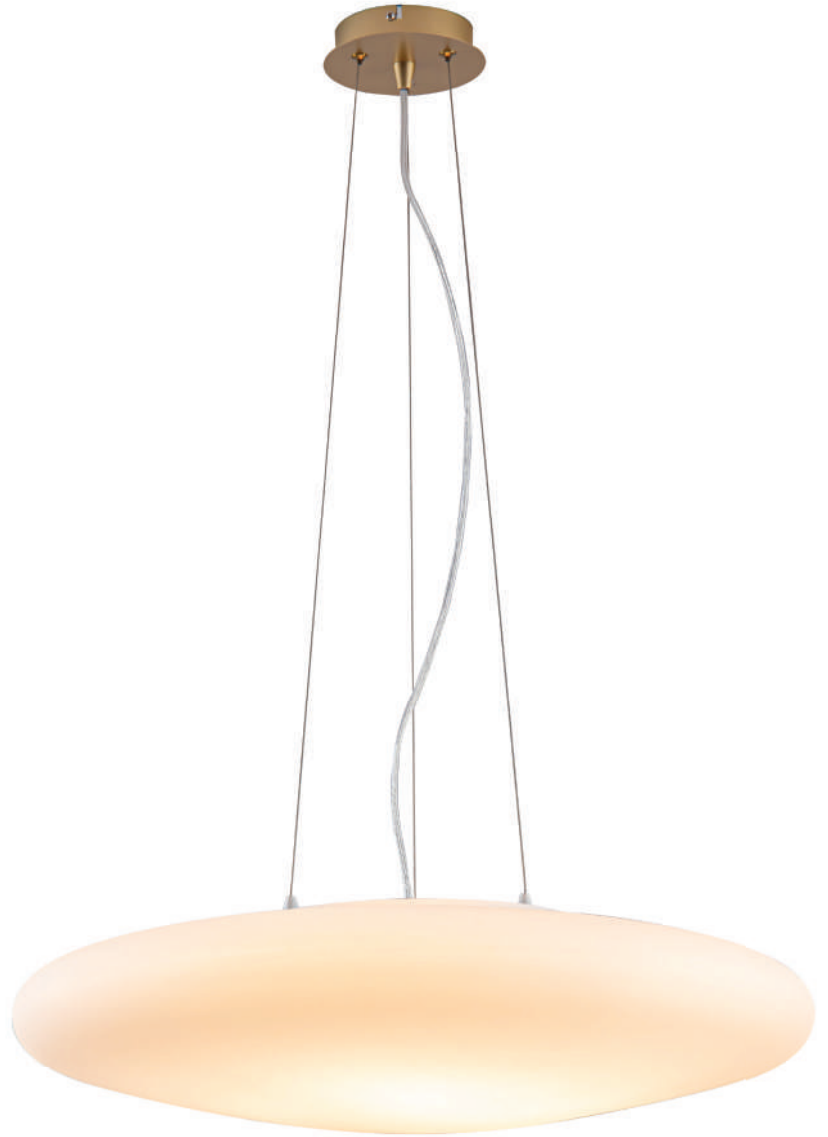

● **PD1801**
Pendente

5XE27 | 200W MAX
D605XA156mm
Bivolt



PD1801

Full Moon

Estrutura: Metal / vidro / acrílico

Difusor: Acrílico

Acabamento: Dourado ou preto

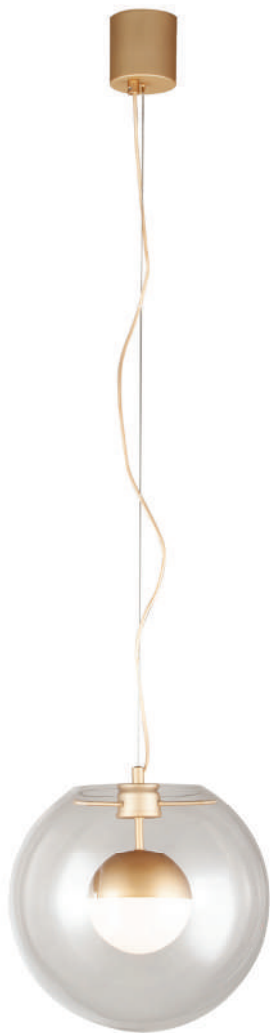

● PD1639DO

● PD1639PT

Pendente

7W / 420lm / 3000K

Dim.: Ø350 x A350 mm

Tensão: Bivolt (127V/220V)

Cabo ajustável até 2000 mm

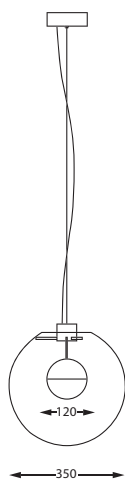



PD1639PT

Ohana

Estrutura: Metal / Vidro

Difusor: Transparente ou champagne

Acabamento: Dourado ou Preto (onix)



● **PD1684DO**
Pendente

LED 10W
Lúmens: 700lm
Temperatura: 3000K
Dimensões: Ø300 x A320 mm
Tensão: Bivolt (127V/220V)
Potência máxima: 10W
Cabo ajustável até 1500 mm



PD1684DO
Cúpula Champagne

PD1684OX
Cúpula Transparente



PD16840X

Plyn

Estrutura: Alumínio
 Difusor: Acrílico branco
 Acabamento: Dourado



● **AB1422**
 Abajur

1xE27 / 40W
 Potência máx.: 40W
 Dimensões: Ø200 x A250 mm
 Tensão: Bivolt (127V/220V)
 Cabo com 1500 mm

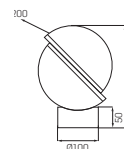

● **AR1421**
 Arandela

Cabo dourado
 1xG9 (LED) / 5W
 Potência máx.: 5W
 Dim.: Ø150 x C180 x A310 mm
 Tensão: Bivolt (127V/220V)

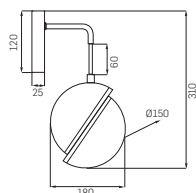



● **PD1420**
Pendente

Cabo dourado
1xE27 / 40W
Potência máx.: 40W
Dimensões: Ø200 x A240 mm
Tensão: Bivolt (127V/220V)
Cabo ajustável até 1500 mm



Lolly

Estrutura: Metal/alumínio

Cúpula: Vidro branco

Acabamento: Bronze



PD1449

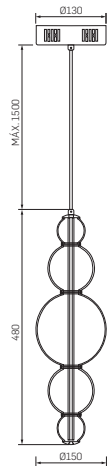

● **PD1448**
Pendente

LED 15W / 1800lm / 3000K
Potência máx.: 15W
Dimensões: Ø150 x A480 mm
Tensão: Bivolt (127V / 220V)
Cabo ajustável até 1500 mm

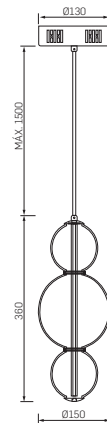

● **PD1449**
Pendente

LED 11W / 1300lm / 3000K
Potência máx.: 11W
Dimensões: Ø150 x A360 mm
Tensão: Bivolt (127V / 220V)
Cabo ajustável até 1500 mm



● **AR1450**
Arandela

LED 11W / 1300lm / 3000K
Potência máx.: 11W
Dim.: Ø150 x L210 x A430 mm
Tensão: Bivolt (127V / 220V)

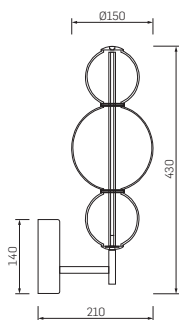

● **PD1451**
Pendente

LED 11W / 1300lm / 3000K
Potência máx.: 11W
Dimensões: Ø100 x A400 mm
Tensão: Bivolt (127V / 220V)
Cabo ajustável até 1500 mm

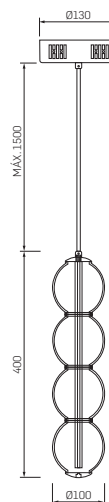

Lolly

Estrutura: Metal/alumínio

Cúpula: Vidro branco

Acabamento: Bronze



● **PD1452**
Pendente

LED 19W / 2100lm / 3000K

Potência máx.: 19W

Dimensões: Ø100 x C600 x A1500 mm

Tensão: Bivolt (127V / 220V)

Cabo ajustável até 1500 mm

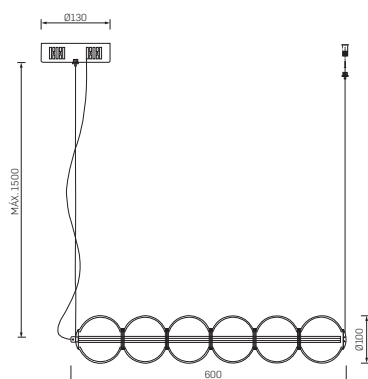

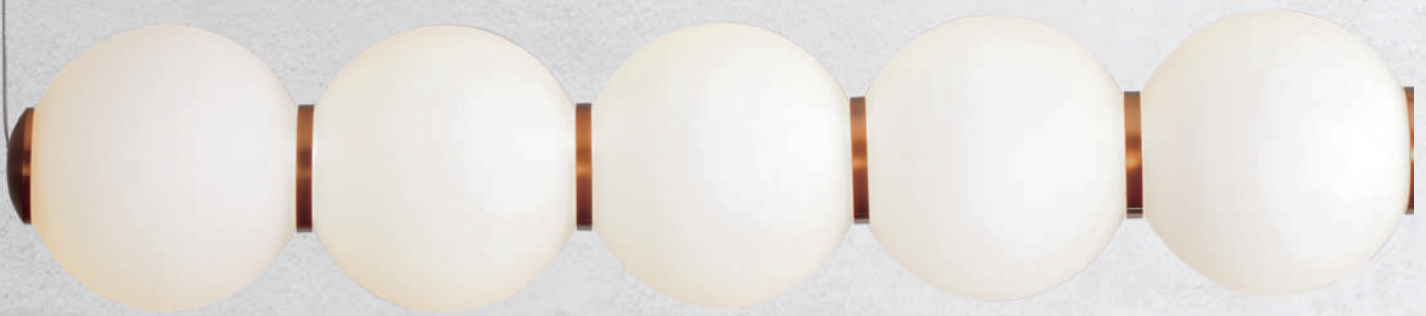



Vermont

Estrutura: Metal/ Vidro
Difusor: Cúpula branco opalino
Acabamento: Dourado



● **PD1753**
Pendente

1xG9 LED 5W
Dimensões: C222 x A180 mm
Tensão: Bivolt (127V/220V)
Potência máxima: 5W
Cabo ajustável até 1500 mm



● **PD1752**
Pendente

2xG9 LED 5W
Dimensões: C432 x A275 mm
Tensão: Bivolt (127V/220V)
Potência máxima: 10W
Cabo ajustável até 1500 mm



● **PD1754**
Pendente

3xG9 LED 5W
Dimensões: C1200 x A257 mm
Tensão: Bivolt (127V/220V)
Potência máxima: 15W
Cabo ajustável até 1500 mm

Lamu

Estrutura: Metal/ Acrílico / Poliestireno

Difusor: Branco

Acabamento: Branco



Luz indireta



PD1751

● **PD1751**
Pendente

LED 3x11w + 3W
Lúmens: 2520lm
Dimensões: C1000 x A1200 mm
Tensão: Bivolt (127V/220V)
Potência máxima: 36W
Cabo ajustável até 1500 mm



Mini Moon

Estrutura: Metal/cúpula de acrílico

Difusor: Branco

Acabamento: Dourado ou Preto



● **PD1638PT**

Pendente

1xG9 Halopin LED 7W

Dimensões: \varnothing 120 x A250 mm

Tensão: Bivolt (127V/220V)

Potência máxima: 7W

Cabo ajustável até 2000 mm



PD1638DO

Acabamento
dourado



PD1638PT

Acabamento preto



Moon

Estrutura: Metal / Alumínio

Difusor: Acrílico

Acabamento: Dourado, Preto ou Branco

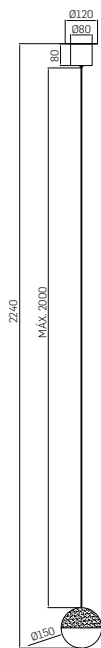

- PD1521DO
- PD1521PT
- PD1521BR
- Pendente D

7W / 420lm / 3000K
 Dimensões: Ø150 x A2240 mm
 Tensão: Bivolt (127V/220V)
 Cabo ajustável até 2000 mm

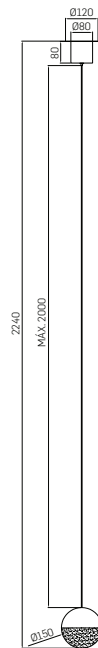

- PD1522DO
- PD1522PT
- PD1522BR
- Pendente U

7W / 420lm / 3000K
 Dimensões: Ø150 x A2240 mm
 Tensão: Bivolt (127V/220V)
 Cabo ajustável até 2000 mm



PD1521PT / PD1522PT

Moon

Estrutura: Metal
 Difusor: Acrílico
 Acabamento: Dourado ou preto



- PD1641DO
 - PD1641PT
- Pendente

14W (2x7W) / 840lm / 3000K
 Dim.: C1120 x L150 x A375 mm
 Tensão: Bivolt (127V/220V)
 Cabo ajustável até 2000 mm

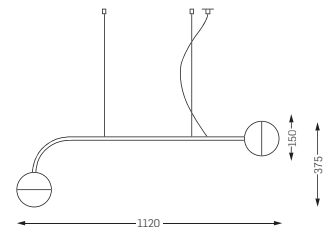

- AR1640DO
 - AR1640PT
- Arandela

7W / 420lm / 3000K
 Dim.: C175 x L150 x A300 mm
 Tensão: Bivolt (127V/220V)

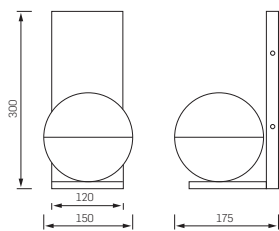



PD1641PT

Moon

Estrutura: Metal

Difusor: Acrílico

Acabamento: Dourado ou preto



● **AB1720DO**

● **AB1720PT**

Abajur

LED 7W

Lúmens: 420lm

Temperatura: 3000K

Dimensões: Ø150 x A240 mm

Tensão: Bivolt (127V/220V)

Potência máxima: 7W

Cabo com 1500 mm



AB1720D0

Triplet

Estrutura: Metal/cúpula de vidro

Difusor: Vidro champagne

Acabamento: Bronze



● **PD1081**
Pendente

LED: 5W
Lúmens: 360lm
Temperatura: 3000K
Dimensões: Ø310 xA150 mm
Tensão: Bivolt (127V/220V)
Potência máxima: 5W
Cabo ajustável até 1500 mm



● **PD1083**
Pendente

LED: 5W
Lúmens: 360lm
Temperatura: 3000K
Dimensões: Ø170 xA295 mm
Tensão: Bivolt (127V/220V)
Potência máxima: 5W
Cabo ajustável até 1500 mm



PD1081 / PD1083

Kane

Estrutura: Metal/ Vidro/ Acrílico
Acabamento: Champagne ou fumê



● **PD1667DO**

Pendente

LED 7W
Lúmens: 400lm
Temperatura: 3000K
Dimensões: Ø380 x A170 mm
Tensão: Bivolt (127V/220V)
Potência máxima: 7W
Cabo ajustável até 1500 mm

● **PD1668DO**

Pendente

LED 7W
Lúmens: 400lm
Temperatura: 3000K
Dimensões: Ø260 x A240 mm
Tensão: Bivolt (127V/220V)
Potência máxima: 7W
Cabo ajustável até 1500 mm



PD1667DO

PD1667OX

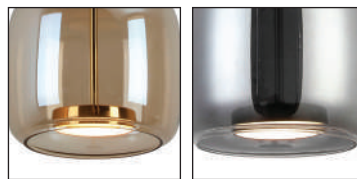

PD1668DO

PD1668OX



● **AB1736DO**

Abajur

LED 7W

Lúmens: 400lm

Temperatura: 3000K

Dimensões: Ø220 x A520 mm

Tensão: Bivolt (127V/220V)

Potência máxima: 7W

Possui cabo com 1500 mm com interruptor liga e desliga para ser ligado a tomada



AB1736DO



AB1736OX

Cadre

Estrutura: Metal/cúpula de vidro
 Difusor: Cúpula champagne ou
 Cúpula branca
 Acabamento: Bronze ou Preto



● **PD1333PT**
 Pendente

1xG9 Halopin LED 5W
 Dimensões: C170 x L120 x A405 mm
 Tensão: Bivolt (127V/220V)
 Potência máxima: 5W
 Cabo ajustável até 1500 mm

● **PD1333BZ-BR**
 Pendente

1xG9 Halopin LED 5W
 Dimensões: C170 x L120 x A405 mm
 Tensão: Bivolt (127V/220V)
 Potência máxima: 5W
 Cabo ajustável até 1500 mm



PD1333PT
 Cúpula champagne

PD1333BZ
 Cúpula champagne



PD1333PT-BR
 Cúpula branca

PD1333BZ-BR
 Cúpula branca



● **PD1334PT**
Pendente

2xG9 Halopin LED 5W
Dimensões: C170 x L120 x A485 mm
Tensão: Bivolt (127V/220V)
Potência máxima: 10W
Cabo ajustável até 1500 mm

● **PD1334BZ-BR**
Pendente

2xG9 Halopin LED 5W
Dimensões: C170 x L120 x A485 mm
Tensão: Bivolt (127V/220V)
Potência máxima: 10W
Cabo ajustável até 1500 mm



PD1334PT
Cúpula champagne

PD1334BZ
Cúpula champagne

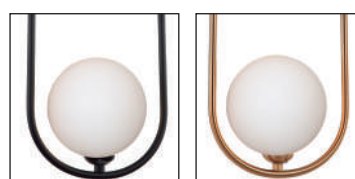

PD1334PT-BR
Cúpula branca

PD1334BZ-BR
Cúpula branca

Cadre

Estrutura: Metal/cúpula de vidro

Difusor: Cúpula champagne ou

Cúpula branca

Acabamento: Bronze ou Preto



PD1333BZ-BR

● PD1329BZ

Pendente

4xG9 Halopin LED 5W

Dimensões: C950 x L120 x A480 mm

Tensão: Bivolt (127V/220V)

Potência máxima: 20W

Cabo ajustável até 1500 mm

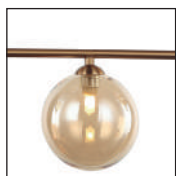

PD1329BZ
Cúpula champagne



PD1329BZ-BR
Cúpula branca



● **AR1332PT**

Arandela

1xG9 Halopin LED 5W
Dimensões: C200 x L120 x A390 mm
Tensão: Bivolt (127V/220V)
Potência máxima: 5W



● **AR1332BZ-BR**

Arandela

1xG9 Halopin LED 5W
Dimensões: C200 x L120 x A390 mm
Tensão: Bivolt (127V/220V)
Potência máxima: 5W

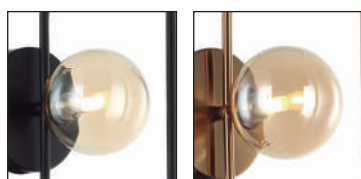

AR1332PT

Cúpula champagne

AR1332BZ

Cúpula champagne

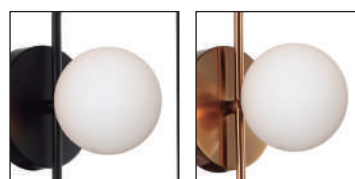

AR1332PT-BR

Cúpula champagne

AR1332BZ-BR

Cúpula branca

Cadre

Estrutura: Metal/cúpula de vidro

Difusor: Cúpula champagne ou

Cúpula branca

Acabamento: Bronze



● **AB1378BZ**

Abajur

1xG9 Halopin LED 5W

Dimensões: C170 x L120 x A420 mm

Tensão: Bivolt (127V/220V)

Potência máxima: 5W

Cabo com 1500 mm com interruptor liga e desliga para ser ligado a tomada



AB1378BZ
Cúpula champagne



AB1378BZ-BR
Cúpula branca

Deuce

Estrutura: Metal/cúpula de vidro
Difusor: Cúpula Branca ou Champagne
Acabamento: Dourado bronze



● **AR1346**

Arandela

2xG9 5W

Dimensões: C170 x L220 x A500 mm

Tensão: Bivolt (127V/220V)

Potência máxima: 10W

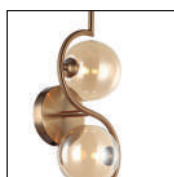

AR1346
2 cúpulas
champagne

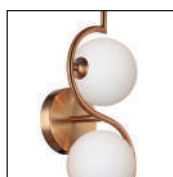

AR1346BR
2 cúpulas branca
opalina



● **PD1347**

Pendente

2xG9 5W

Dimensões: C170 x L120 x A495 mm

Tensão: Bivolt (127V/220V)

Potência máxima: 10W

Cabo ajustável até 1500 mm



PD1347
2 cúpulas
champagne



PD1347BR
2 cúpulas branca
opalina

Bead

Estrutura: Metal/cúpula de vidro
 Difusor: Cúpula champagne ou
 Cúpula fumê
 Acabamento: Preto ou Dourado



● **QAB1323FM**
Abajur

1xE27 40W (lâmpada LED de filamento)
 Dimensões: Ø140 x A215 mm
 Tensão: Bivolt (127V/220V)
 Potência máxima: 40W
 Possui cabo com 1500 mm com interruptor liga
 e desliga para ser ligado a tomada



QAB1323FM



QAB1323CH



● **QPD1324CH**
Pendente

1xE27 40W (lâmpada LED de filamento)
 Dimensões: Ø140 x A215 mm
 Tensão: Bivolt (127V/220V)
 Potência máxima: 40W
 Cabo ajustável até 1500 mm



QPD1324CH



QPD1324CH

Ravelo

Estrutura: Metal/cúpula de vidro

Difusor: Cúpula fumê ou Cúpula champagne

Acabamento: Preto ou Dourado



● **PDH1581CH**

Pendente

1xE27 40W

Dimensões: Ø150 x A300 mm

Tensão: Bivolt (127V/220V)

Potência máxima: 40W

Cabo ajustável até 1500 mm

● **PDH1582CH**

Pendente

5xE27 40W

Dimensões: C1185 x L150 x A250 mm

Tensão: Bivolt (127V/220V)

Potência máxima: 200W

Cabo ajustável até 1500 mm



PDH1581FM

1 cúpula fumê



PDH1581CH

1 cúpula champagne



PDH1582FM

5 cúpula fumê



PDH1582CH

5 cúpula champagne



PDH1581FM

Torchia

Estrutura: Metal/cúpula de vidro

Difusor: Cúpula champagne

Acabamento: Dourada



● **AR1462**

Arandela

1xE27 40W

Dimensões: C353 x L150 x A203 mm

Tensão: Bivolt (127V/220V)

Potência máxima: 40W



● **PD1464**

Pendente

5xE27 40W

Dimensões: C1140 x L580 x A750 mm

Tensão: Bivolt (127V/220V)

Potência máxima: 200W

Haste ajustável até 700mm (400mm+300mm)



● **PD1465**

Pendente

7xE27 40W

Dimensões: C1300 x L700 x A750 mm

Tensão: Bivolt (127V/220V)

Potência máxima: 280W

Haste ajustável até 700mm (400mm+300mm)



PD1465

Cutie

Estrutura: Metal/cúpula de vidro

Difusor: Cúpula champagne ou

Cúpula fumê

Acabamento: Cobre ou Preto



● **PD1330CH**

Pendente

4xE27 40W

Dimensões: C910 x L150 x A360 mm

Tensão: Bivolt (127V/220V)

Potência máxima: 160W

Cabo ajustável até 1500 mm

● **PD1331FM**

Pendente

6xE27 40W

Dimensões: 720 x A605 mm

Tensão: Bivolt (127V/220V)

Potência máxima: 240W

Cabo ajustável até 1500 mm



PD1330CH

4 cúpulas
champagne

PDH1330FM

4 cúpulas fumê

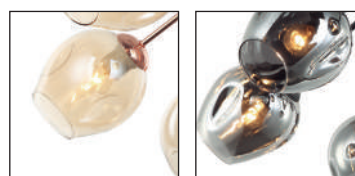

PD1331CH

6 cúpulas
champagne

PD1331FM

6 cúpulas fumê



PD1330FM

Eden

Estrutura: Metal/ Vidro

Cúpula: Cúpula Transparente /

Champagne / Fumê

Acabamento: Preto ou Dourado



● **PD1755FM**

Pendente

1xG9 LED 5W

Dimensões: Ø150 x A215 mm

Tensão: Bivolt (127V/220V)

Potência máxima: 5W

Cabo ajustável até 1500 mm



PD1755TR
Vidro transparente



PD1755CH
Vidro champagne



PD1755FM
Vidro fumê

Jetty

Estrutura: Metal/cúpula de vidro
Difusor: Cúpula Cobre, Cúpula fumê
ou Cúpula champagne
Acabamento: Preto / Dourado



PD1492FM

● **PD1429CH**
Pendente

1xE27 40W
Dimensões: Ø150 xA210 mm
Tensão: Bivolt (127V/220V)
Potência máxima: 40W
Cabo ajustável até 1500 mm



PD1429CO
Cúpula cobre



PD1429FM
Cúpula fumê



PD1429CH
Cúpula champagne

Drip

Estrutura: Metal/cúpula de vidro

Difusor: Cúpula champagne

Acabamento: Dourado



AR1382CH



● **AR1382CH**
Arandela

1xG9 5W

Dimensões: Ø120 xA230 mm

Tensão: Bivolt (127V/220V)

Potência máxima: 5W



● **PD1077-CH**
Pendente

1xG9 5W

Dimensões: Ø120 xA230 mm

Tensão: Bivolt (127V/220V)

Potência máxima: 5W

Cabo ajustável até 1500 mm

Tear

Estrutura: Metal/cúpula de vidro com cristais

Difusor: Cúpula transparente com cristais transparentes

Acabamento: Cobre



● **AR1433**
Arandela

1 xG9 (LED) 5W
Dimensões: C120 xL130 x A300 mm
Tensão: Bivolt (127V/220V)
Potência máxima: 5W



● **PD1434**
Pendente

1 xG9 (LED) 5W
Dimensões: Ø90 xA 225 mm
Tensão: Bivolt (127V/220V)
Potência máxima: 5W
Cabo ajustável até 1500 mm



Clam

Estrutura: Metal/cúpula de vidro

Difusor: Vidro transparente ou

Vidro champagne

Acabamento: Cromado ou Champagne



● **PD622**
Pendente

1xGU10 50W
Dimensões: Ø120 x A600 mm
Tensão: Bivolt (127V/220V)
Potência máxima: 50W
Cabo ajustável até 1500 mm



● **AR1380DO**
Arandela

1xGU10 50W
Dimensões: Ø120 x A450 mm
Tensão: Bivolt (127V/220V)
Potência máxima: 50W



PD622
Vidro transparente



PD622-D0
Vidro champagne



AR1380DO
Vidro champagne



AR1380CR
Vidro transparente



PD622-DO

Dublin

Estrutura: Metal/cúpula de vidro e pingentes de cristal
 Difusor: Cúpula cromada ou Cúpula cobre
 Acabamento: Cromada ou Cobre



● **QPD1279-CR**

Pendente

1 xG9 40W
 Dimensões: Ø130 x A150 mm
 Tensão: Bivolt (127V/220V)
 Potência máxima: 40W
 Cabo ajustável até 1500 mm



● **QAR1281-CO**

Arandela

1 xG9 40W
 Dimensões: Ø130 x C190 x A160 mm
 Tensão: Bivolt (127V/220V)
 Potência máxima: 40W



QPD1279-CO
Cúpula cobre



QPD1279-CR
Cúpula cromada



QAR1281-CO
Cúpula cobre



QAR1281-CR
Cúpula cromada

Spring

Estrutura: Metal / cristais

Difusor: Cristais transparentes ou

Cristais ambar

Acabamento: Cobre ou Dourada



● **LT638-DO**

Lustre

6xG9 5W

Dimensões: Ø530 x A530 mm

Tensão: Bivolt (127V/220V)

Potência máxima: 5W

Cabo ajustável até 1500 mm

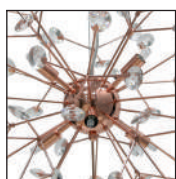

LT638
Cobre

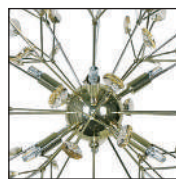

LT638-DO
Dourado

Cálico

Estrutura: Metal/cúpula de vidro

Difusor: Cúpula cromada ou

Cúpula cobre

Acabamento: Preto



● **PD1290-CR**

Pendente

1xE27 40W

Dimensões: Ø250 xA250 mm

Tensão: Bivolt (127V/220V)

Potência máxima: 40W

Cabo ajustável até 1500 mm

● **PD1291-CO**

Pendente

1xE27 40W

Dimensões: Ø350 xA350 mm

Tensão: Bivolt (127V/220V)

Potência máxima: 40W

Cabo ajustável até 1500 mm

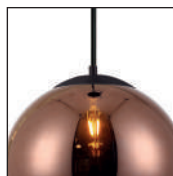

PD1290-CR

1 cúpula cromada

PD1290-CO

1 cúpula cobre



PD1291-CR

1 cúpula cromada

PD1291-CO

1 cúpula cobre



PD1290-CR

Classic

Estrutura: Metal/cúpula de vidro

Difusor: Cúpula transparente

Acabamento: Cor madeira



● **606**
Pendente

1xE27 40W
Dimensões: Ø200 xA240 mm
Tensão: Bivolt (127V/220V)
Potência máxima: 40W
Cabo ajustável até 1500 mm

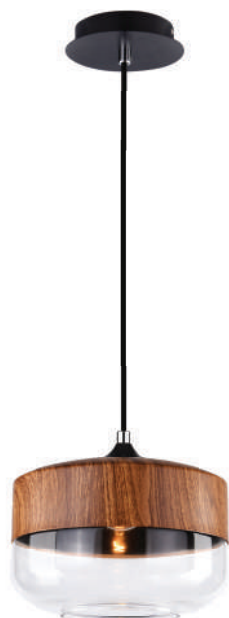

● **609**
Pendente

1xE27 40W
Dimensões: Ø250 xA250 mm
Tensão: Bivolt (127V/220V)
Potência máxima: 40W
Cabo ajustável até 1500 mm



● **617**
Pendente

1xE27 40W
Dimensões: Ø130 xA320 mm
Tensão: Bivolt (127V/220V)
Potência máxima: 40W
Cabo ajustável até 1500 mm



609

Hilton

Estrutura: Metal/cúpula de vidro
 Difusor: Cúpula transparente
 Acabamento: Preto ou Dourado



AR1719PT



● **PD1432DO**
 Pendente

1xGU10 50W
 Dimensões: Ø70 x A430 mm
 Tensão: Bivolt (127V/220V)
 Potência máxima: 50W
 Cabo ajustável até 2000 mm

● **AR1719PT**
 Arandela

1xGU10 50W
 Dimensões: L70 x P120 x A170 mm
 Tensão: Bivolt (127V/220V)
 Potência máxima: 50W



PD1432DO

PD1432PT



AR1719DO

AR1719PT



PD1432PT

Pellet

Estrutura: Metal/cúpula de vidro
 Difusor: Cúpula branca
 Acabamento: Dourado ou Preto

NOVO
 ACABAMENTO
PRETO



● **PD1236**
 Pendente

1xG9 5W
 Dimensões: Ø120 xA105 mm
 Tensão: Bivolt (127V/220V)
 Potência máxima: 5W
 Cabo ajustável até 1500 mm



● **PD1235**
 Pendente

1xG9 5W
 Dimensões: Ø120 xA130 mm
 Tensão: Bivolt (127V/220V)
 Potência máxima: 5W
 Cabo ajustável até 1500 mm



● **PD1237**
 Pendente

1xG9 5W
 Dimensões: Ø150 xA95 mm
 Tensão: Bivolt (127V/220V)
 Potência máxima: 5W
 Cabo ajustável até 1500 mm



PD1235
 Acabamento
 dourado



PD1235PT
 Acabamento preto

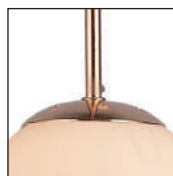

PD1236
 Acabamento
 dourado

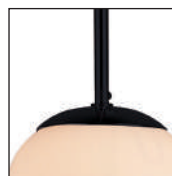

PD1236PT
 Acabamento preto

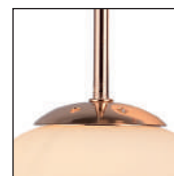

PD1237
 Acabamento
 dourado

Spire

Estrutura: Metal/cúpula de vidro
Difusor: Cúpula champagne /
Cúpula fumê
Acabamento: Preto ou Dourado



● **QPD1348CH**
Pendente

1xE27 40W (lâmpada LED de filamento)
Dimensões: Ø90 xA300 mm
Tensão: Bivolt (127V/220V)
Potência máxima: 40W
Cabo ajustável até 1500 mm



QAB1325FM



● **QAB1325CH**
Abajur

1xE27 40W (lâmpada LED de filamento)
Dimensões: Ø90 xA300 mm
Tensão: Bivolt (127V/220V)
Potência máxima: 40W
Possui cabo com 1500 mm com interruptor liga e desliga para ser ligado a tomada



QAB1325CH



QAB1325FM

Linse

Estrutura: Metal/ Vidro/ Lente
Difusor: Vidro
Acabamento: Preto ou Dourado



Canopla compacta exclusiva para forros de gesso

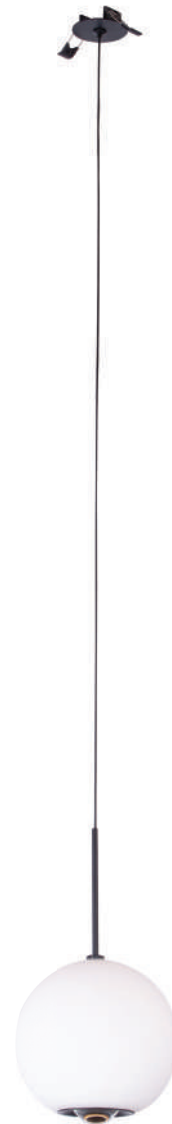

● **PD1714PT**
Pendente

LED 8W
Lúmens: 480lm
Temperatura: 3000K
Dimensões: Ø150 x L150 x A270 mm
Tensão: Bivolt (127V/220V)
Potência máxima: 8W
Cabo ajustável até 2000 mm



PD1714PT



PD1714DO

Augen

Estrutura: Metal/ Lente
Acabamento: Preto (Onix) ou Dourado



Canopla compacta exclusiva para forros de gesso

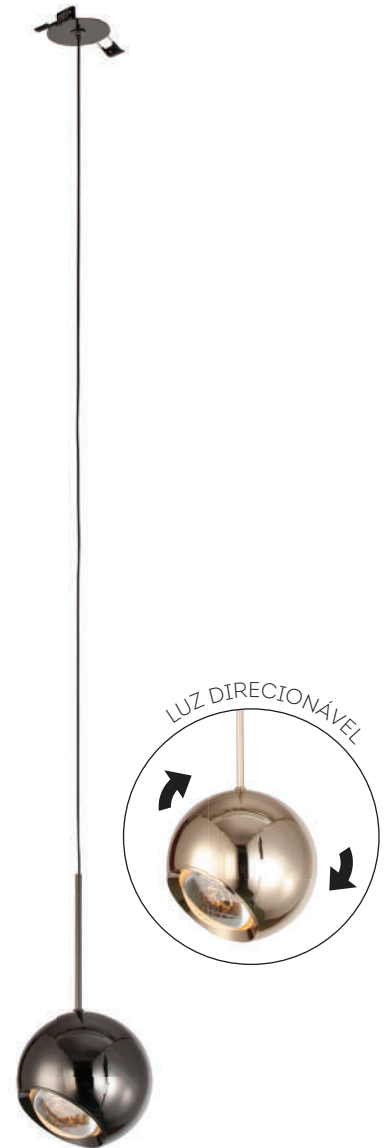

● **PD17210X**
Pendente

LED 7W
Lúmens: 420lm
Potência: 3000K
Dimensões: Ø120 x L120 x A240 mm
Tensão: Bivolt (127V/220V)
Potência máxima: 7W
Cabo ajustável até 2000 mm



PD17210X

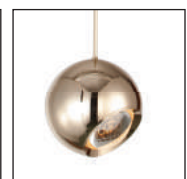

PD1721DO

Vega

Estrutura: Metal

Acabamento: Branco, Marrom ou Preto
com detalhe em Cobre ou Dourado.



QPD1163-PT



● **QAR1483-PT**

Arandela

1 x E27 | 40W

Dimensões: C279 x L206 x A202 mm

Tensão: Bivolt (127V/220V)

Potência máxima: 40W



QAR1483-PT
Acabamento branco
detalhe cobre

NOVO ACABAMENTO



QAR1483-PTDO
Acabamento preto
detalhe dourado



● **QPD1163-PTDO**

Pendente

1 x E27 | 40W

Dimensões: Ø200 x A160 mm

Tensão: Bivolt (127V/220V)

Potência máxima: 40W

Cabo ajustável até 1500 mm



QPD1163-BR
Acabamento branco
detalhe cobre



QPD1163-PT
Acabamento preto
detalhe cobre

NOVO ACABAMENTO



QPD1163-PTDO
Acabamento preto
detalhe dourado

Dome

Estrutura: Metal/ Cúpula de tecido

Cúpula: Branca

Acabamento: Cromado ou Cobre



● **PD947-CR**

Pendente

1x E27 40W

Dimensões: Ø340 x A250 mm

Tensão: Bivolt (127V/220V)

Potência máxima: 40W

Haste 118 mm



PD947-CR
Acabamento cromado



PD947-CO
Acabamento cobre

Drain

Estrutura: Alumínio

Cúpula: Tecido branco ou preto

Acabamento: Cromado ou preto



Hastes ajustáveis



● AR977

● AR977PT

Arandela

1xE27 / 40W

Potência máx.: 40W

Dim.: L370~870 x A270~570 mm

Cúpula Ø200 mm

Tensão: Bivolt (127V/220V)

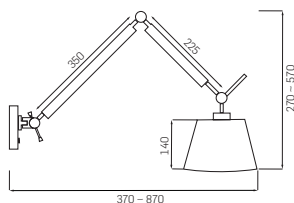



● AR978

● AR978PT

Arandela

1xE27 / 40W

Potência máx.: 40W

Dim.: L285 x A270 mm

Cúpula Ø200 mm

Tensão: Bivolt (127V/220V)

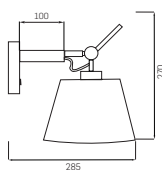

Drain

Estrutura: Alumínio

Cúpula: Tecido branco ou preto

Acabamento: Cromado ou preto



Hastes ajustáveis



- PD976
 - PD976PT
- Pendente

1xE27 / 40W
Potência máx.: 40W
Dim.: C260~640 x A600~1400 mm
Cúpula Ø260 mm
Tensão: Bivolt (127V/220V)

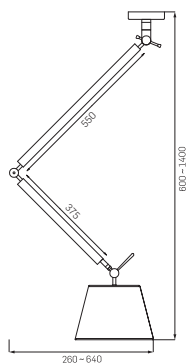



PD976

Drain





PD976PT

Drain Office

Estrutura: Alumínio e metal

Cúpula: Alumínio e metal

Acabamento: Prata/cromado ou preto



Hastes ajustáveis

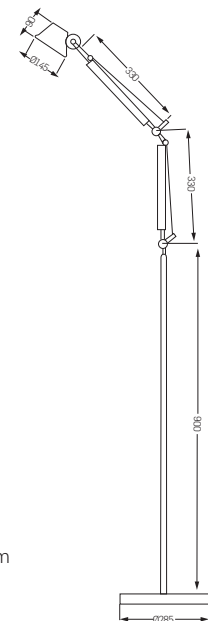

● LM1603

● LM1603PT

Luminária de mesa

1xE27 / 40W

Potência máx.: 40W

Dim.: C500 x L210 x A633 mm

Cúpula Ø145 mm

Tensão: Bivolt (127V/220V)

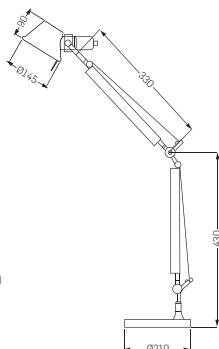

● CL1604

● CL1604PT

Coluna

1xE27 / 40W

Potência máx.: 40W

Dim.: C800 x L280 x A1650 mm

Cúpula Ø145 mm

Tensão: Bivolt (127V/220V)



- AR1605
- AR1605PT

Arandela

1xE27 / 40W
 Potência máx.: 40W
 Dim.: C260 x L115 x A230 mm
 Cúpula Ø145 mm
 Tensão: Bivolt (127V/220V)

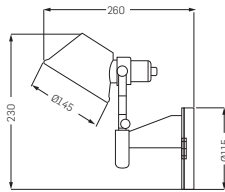

- AR1606
- AR1606PT

Arandela

1xE27 / 40W
 Potência máx.: 40W
 Dim.: C850 x L115 x A370 mm
 Cúpula Ø145 mm
 Tensão: Bivolt (127V/220V)

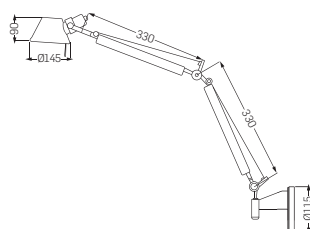



AR1606

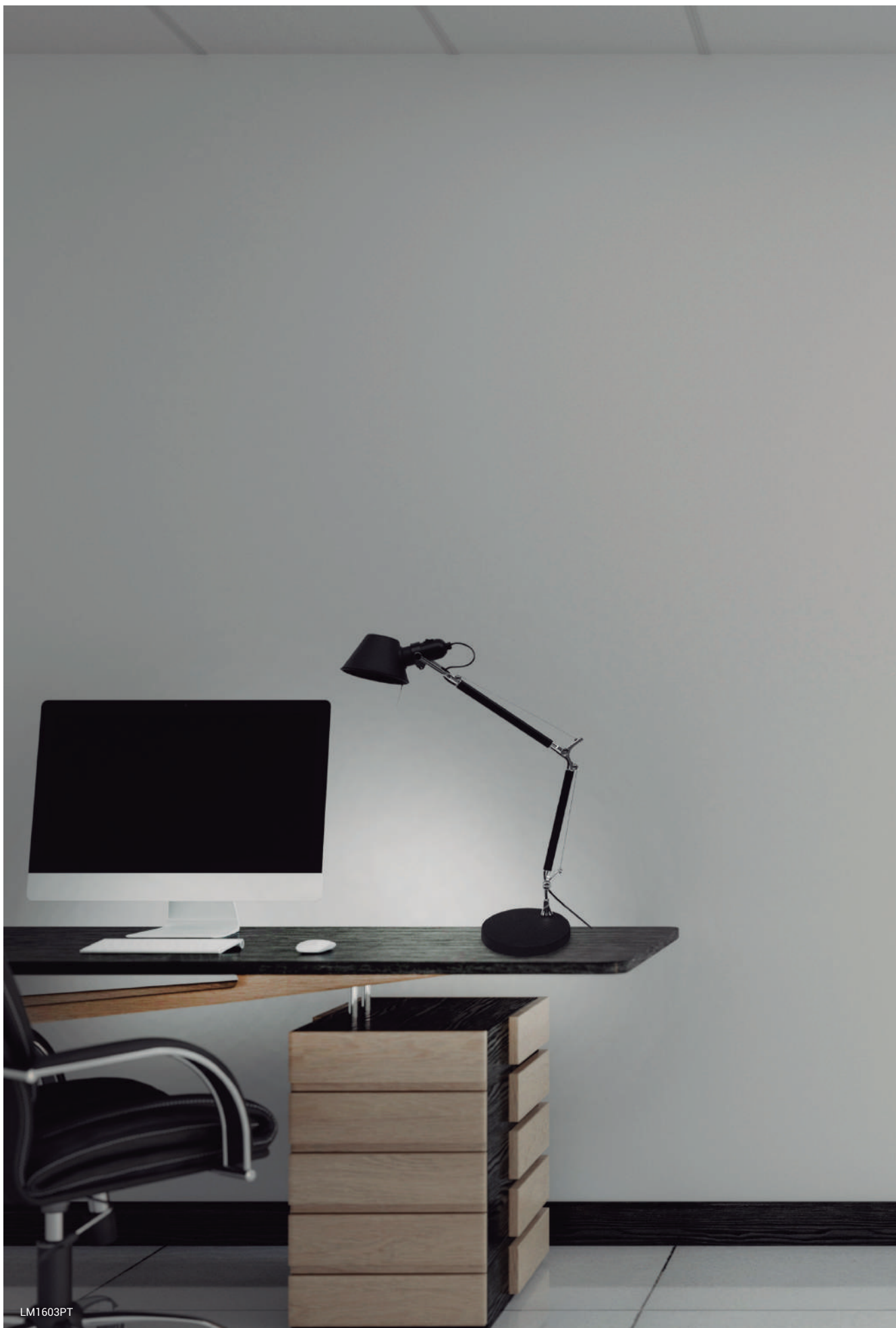

LM1603PT

Cozy

Estrutura: Metal/Cúpula de tecido

Cúpula: Branco

Acabamento: Branco, Preto
ou Cromado



QAR1337CR

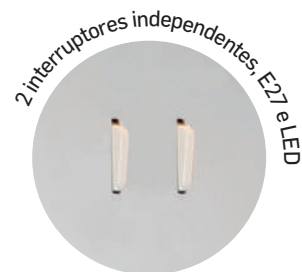

● QAR1337CR

Arandela

1 x E27 | 40W + LED 2W

Lúmens: 80lm

Temperatura: 3000K

Dimensões: C160 x L170 x A300 mm

Tensão: Bivolt (127V/220V)

Potência máxima: 16W

Cabo ajustável até 1500 mm



QAR1337BR
Acabamento branco



QAR1337CR
Acabamento cro-
mado



QAR1337PT
Acabamento preto

Aniko

Estrutura: Alumínio
Acabamento: Branco ou Preto



● **AR1428BR**
Arandela

1x E27 40W
Dimensões: C350 x L130 x A320 mm
Tensão: Bivolt (127V/220V)
Potência máxima: 40W
Possui cabo com 1500 mm com interruptor liga e desliga para ser ligado a tomada



AR1428BR
Acabamento branco



AR1428PT
Acabamento preto



AR1428PT

Haus

Estrutura: Metal

Acabamento: Branco ou Preto

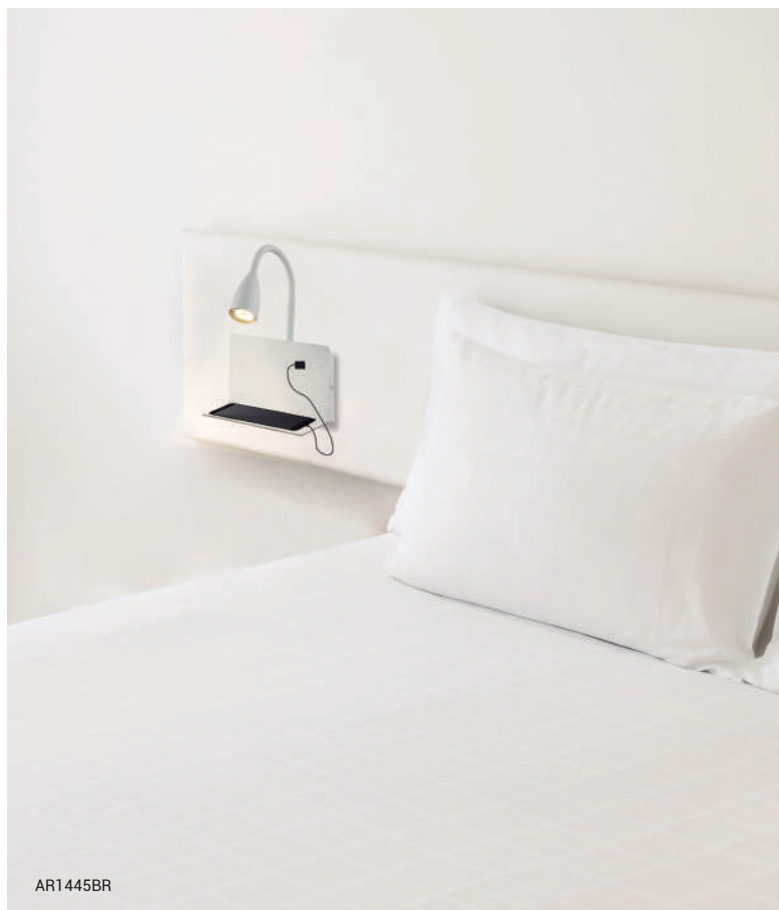

● **AR1445PT**
Arandela

1 x GU10 LED | 20W
Dimensões: C230 x L200 x A290 mm
Tensão: Bivolt (127V/220V)
Potência máxima: 20W



AR1445BR

Acabamento branco

AR1445PT

Acabamento preto

Vision

Estrutura: Alumínio

Acabamento: Branco ou Prata ou Preto

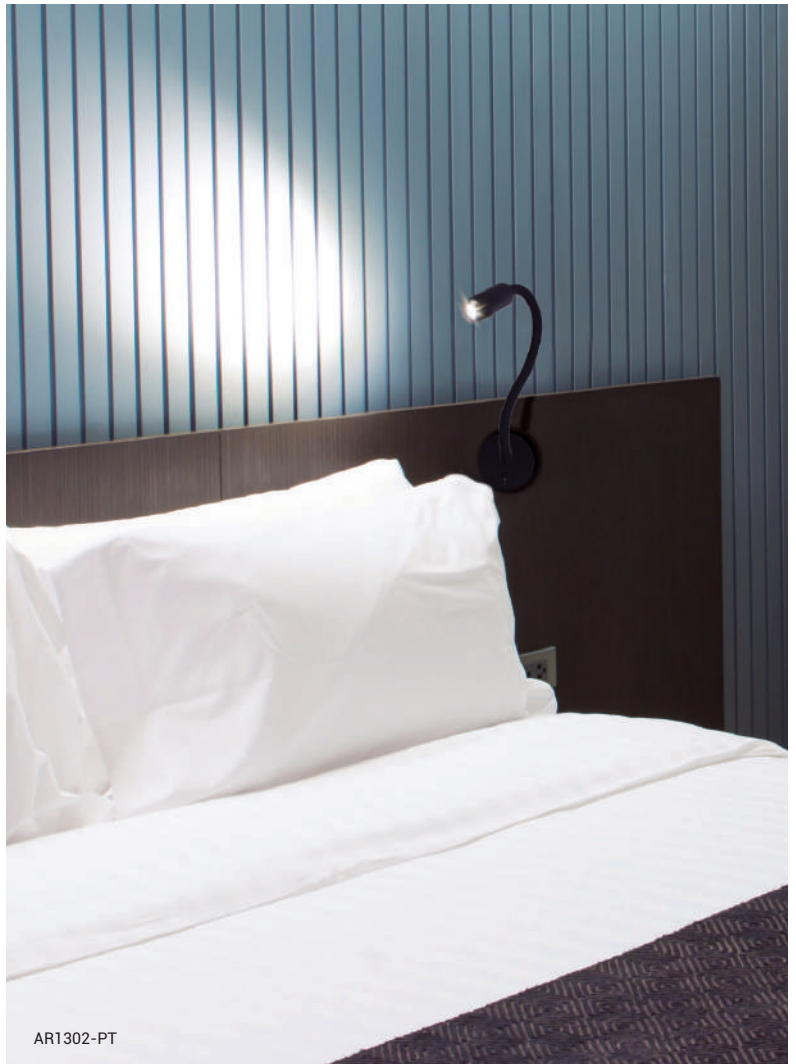

AR1302-PT

● **AR1302-PR**
Arandela

LED 3W
Lúmens: 300lm
Temperatura: 3000K
Dimensões: L85 x A455 mm
Tensão: Bivolt (127V/220V)
Potência máxima: 3W

Interruptor liga/desliga



AR1302-BR
Acabamento branco



AR1302-PR
Acabamento prata

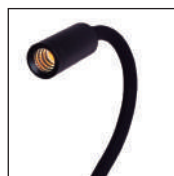

AR1302-PT
Acabamento preto

Pipe

Estrutura: Alumínio

Acabamento: Branco ou Preto

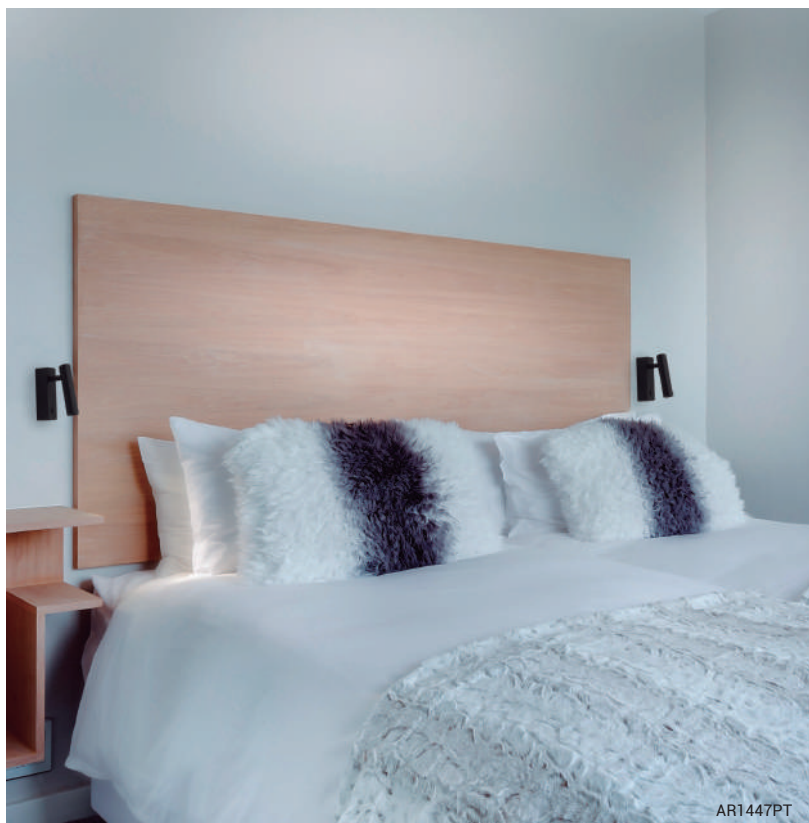

AR1447PT



Interruptor liga/desliga



● **AR1447BR**

Arandela

LED 3W

Lúmens: 300lm

Temperatura: 3000K

Dimensões: C130 x L37 x A95 mm

Tensão: Bivolt (127V/220V)

Potência máxima: 3W



AR1447BR

Acabamento branco

AR1447PT

Acabamento preto

Roof

Estrutura: Alumínio/Acrílico e aço inox

Difusor: Difusor branco

Acabamento: Cromada



AR803



● **AR803**
Arandela

LED 8W
Lúmens: 321lm
Temperatura: 3000K
Dimensões: C452 x L45 x A125,8 mm
Tensão: Bivolt (127V/220V)
Potência máxima: 8W



● **AR804**
Arandela

LED 12W
Lúmens: 554lm
Temperatura: 3000K
Dimensões: C595 x L45 x A125 mm
Tensão: Bivolt (127V/220V)
Potência máxima: 12W

Askin

Estrutura: Metal

Acabamento: Branco, Marrom ou Preto
com detalhes em cobre



● **QPD1161-PT**
Pendente

1 x E27 | 40W
Dimensões: Ø300 x A335 mm
Tensão: Bivolt (127V/220V)
Potência máxima: 40W
Cabo ajustável até 1500 mm



QPD1161-BR
Acabamento branco



QPD1161-MR
Acabamento marrom
detalhe cobre



QPD1161-PT
Acabamento preto
detalhe cobre



OPD1161-BR

Beaver

Estrutura: Metal

Acabamento: Branco com detalhe em aço escovado/ Preto com detalhe em cobre



● **AR862-BR**
Arandela

1 x E27 | 40W
Dimensões: C165 x L530 x A700 mm
Tensão: Bivolt (127V/220V)
Potência máxima: 40W



● **LM860-PT**
Luminária de mesa

1 x E27 | 40W
Dimensões: C230 x L550 x A745 mm
Tensão: Bivolt (127V/220V)
Potência máxima: 40W
Possui cabo com interruptor liga e desliga para ser ligado a tomada

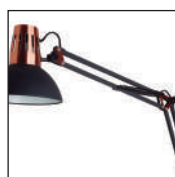

AR862-BR

Acabamento branco
detalhe aço
escovado

AR862-PT

Acabamento preto
detalhe cobre



LM860-BR

Acabamento branco
detalhe aço
escovado

LM860-PT

Acabamento preto
detalhe cobre



● **CL861-BR**
Coluna

1 x E27 | 40W
Dimensões: C250 x L1700 x A550 mm
Tensão: Bivolt (127V/220V)
Potência máxima: 40W
Possui cabo com interruptor liga e desliga
para ser ligado a tomada



CL861-BR
Acabamento branco
detalhe aço escovado

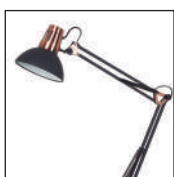

CL861-PT
Acabamento preto
detalhe cobre



CL861-PT

Bergen

Estrutura: Metal

Acabamento: Preto com detalhe cromado



● **QCL1152-PT**
Coluna

1 x E27 | 40W

Dimensões: C340 x L205 x A1320 mm

Tensão: Bivolt (127V/220V)

Potência máxima: 40W

Possui cabo com interruptor liga e desliga para ser ligado a tomada



QCL1152-PT

Bergen

Estrutura: Metal

Acabamento: Branco com detalhe cromado / Preto com detalhe cobre



com interruptor
liga/desliga

● **QAR1153-BR**
Arandela

1 x E27 | 40W
Dimensões: C225 x L120 x A170 mm
Tensão: Bivolt (127V/220V)
Potência máxima: 40W



● **QPD1158-PT**
Pendente

1 x E27 | 40W
Dimensões: Ø170 x A180 mm
Tensão: Bivolt (127V/220V)
Potência máxima: 40W
Cabo ajustável até 1500 mm



QAR1153-BR
Acabamento branco
detalhe cromado

QAR1153-PT
Acabamento preto
detalhe cobre



QPD1158-BR
Acabamento branco
detalhe cromado

QPD1158-PT
Acabamento preto
detalhe cobre

Brande

Estrutura: Metal

Acabamento: Branco com detalhes cromado / Preto com detalhes cobre



● **QLM1160-BR**
Luminária de mesa

1 x E27 | 40W
Dimensões: C390 x L150 x A520 mm
Tensão: Bivolt (127V/220V)
Potência máxima: 40W
Possui cabo com interruptor liga e desliga para ser ligado a tomada



QLM1160-BR

Acabamento branco/
detalhe cromado

QLM1160-PT

Acabamento preto/
detalhe cobre



QLM1160-PT

Nexus

Estrutura: Metal

Acabamento: Aço escovado ou Cobre

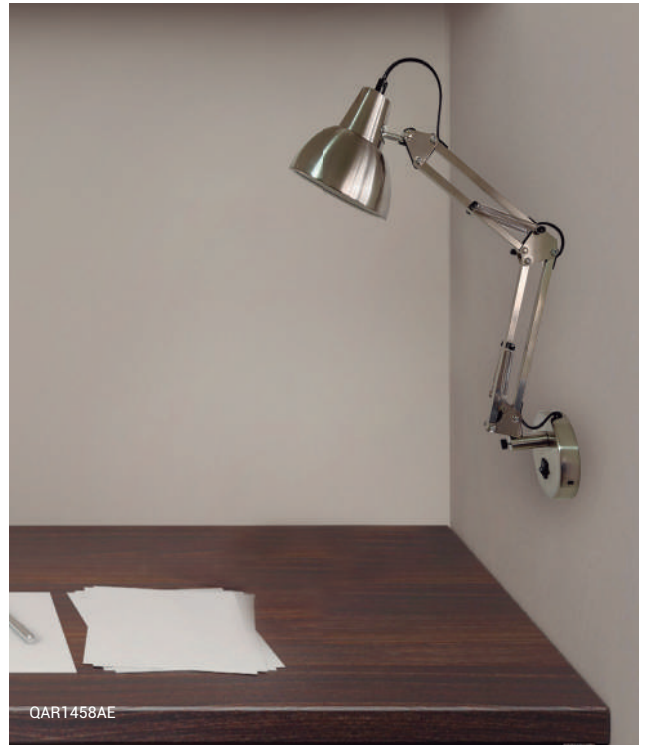

● **LM1060-CO**
Luminária de mesa

1 x E27 | 40W
Dimensões: Ø135 x A530 mm
Tensão: Bivolt (127V/220V)
Potência máxima: 40W
Possui cabo com interruptor liga e desliga para ser ligado a tomada



● **QAR1458AE**
Arandela

1 x E27 | 40W
Dimensões: L160 x C220 x A510 mm
Tensão: Bivolt (127V/220V)
Potência máxima: 40W



LM1060-AE
Acabamento aço escovado

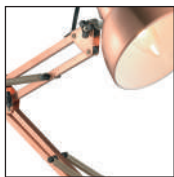

LM1060-CO
Acabamento cobre



QAR1458-AE
Acabamento aço escovado



QAR1458-CO
Acabamento cobre

Helmet

Estrutura: Metal

Acabamento: Branco com detalhes em aço escovado / Preto com detalhes em cobre

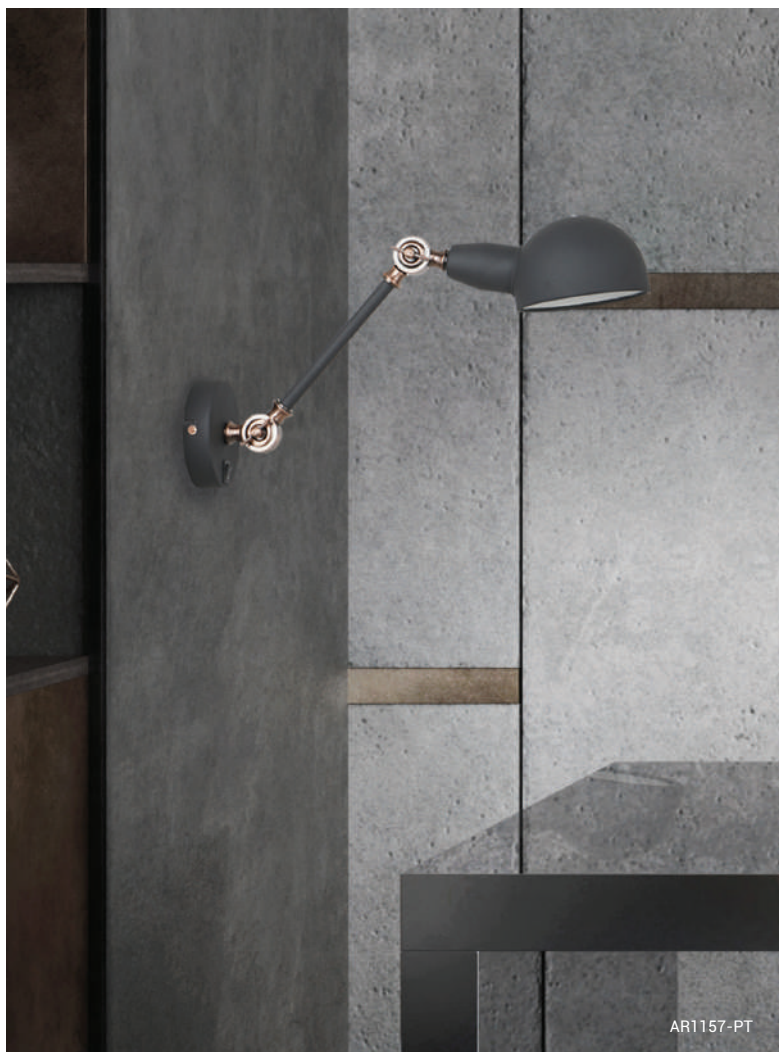

AR1157-PT

● **AR1157-BR**

Arandela

1 x E27 | 40W

Dimensões: C120 x L370 x A295 mm

Tensão: Bivolt (127V/220V)

Potência máxima: 40W

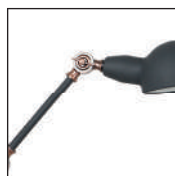

AR1157-BR

Acabamento branco/
detalhe aço escovado

AR1157-PT

Acabamento preto/
detalhe cobre



com interruptor
liga/desliga

Hamar

Estrutura: Metal

Acabamento: Branco ou Cinza com detalhe em cobre



com interruptor
liga/desliga

● **QAR1154-BR**

Arandela

1 x E27 | 40W

Dimensões: C335 x L190 x A210 mm

Tensão: Bivolt (127V/220V)

Potência máxima: 40W



QAR1154-CZ



QAR1154-BR

Acabamento branco
detalhe cobre

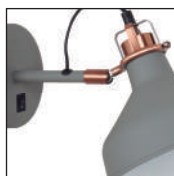

QAR1154-CZ

Acabamento cinza
detalhe cobre

Horn

Estrutura: Metal/ Madeira
 Madeira: Natural
 Acabamento: Branco ou preto



● **QLM1064-BR**
 Luminária de mesa

1 x G9 | 5W
 Dimensões: L180 x A490 mm
 Base: Ø140
 Tensão: Bivolt (127V/220V)
 Potência máxima: 5W
 Possui cabo com interruptor liga e desliga
 para ser ligado a tomada



QLM1064-BR
 Acabamento branco

QLM1064-AE
 Acabamento aço
 escovado

QLM1064-CO
 Acabamento cobre

QLM1064-PT
 Acabamento preto

Horn

Estrutura: Metal/ Madeira

Madeira: Natural

Acabamento: Branco, Preto, Aço

Escovado ou Cobre



● **QPD1063-PT**

Pendente

1 x G9 | 5W

Dimensões: Ø125 x A190 mm

Tensão: Bivolt (127V/220V)

Potência máxima: 5W

Cabo ajustável até 1500 mm



QPD1063-AE



QPD1063-BR
Acabamento branco



QPD1063-AE
Acabamento aço
escovado



QPD1063-CO
Acabamento cobre



QPD1063-PT
Acabamento preto

Horn

Estrutura: Metal/ Madeira
 Madeira: Natural
 Acabamento: Branco, Preto, Aço
 Escovado ou Cobre



● **QAR1457AE**
 Arandela

1 x G9 | 5W
 Dimensões: L125 x C230 x A360 mm
 Tensão: Bivolt (127V/220V)
 Potência máxima: 5W
 Possui cabo com interruptor liga e desliga
 para ser ligado a tomada



QAR1457PT



QAR1457BR
 Acabamento branco



QAR1457AE
 Acabamento aço
 escovado



QAR1457CO
 Acabamento cobre



QAR1457PT
 Acabamento preto



Horn

Estrutura: Metal/ Madeira
Madeira: Natural
Acabamento: Branco, Preto, Aço
Escovado ou Cobre



● **QAR1466PT**

Arandela

1 x G9 | 5W

Dimensões: L125 x C180 x A190 mm

Tensão: Bivolt (127V/220V)

Potência máxima: 5W



QAR1466BR
Acabamento branco



QAR1466PT
Acabamento preto

Horn

Estrutura: Metal/ Madeira
 Madeira: Natural
 Acabamento: Branco, Preto, Aço
 Escovado ou Cobre



● **QCL1467AE**

Coluna

1 x G9 | 5W

Dimensões: L230 x C240 x A1400 mm

Tensão: Bivolt (127V/220V)

Potência máxima: 5W

Possui cabo com interruptor liga e desliga para ser ligado a tomada



QCL1467BR
Acabamento branco

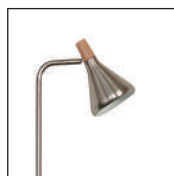

QCL1467AE
Acabamento aço escovado

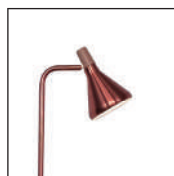

QCL1467CO
Acabamento cobre



QCL1467PT
Acabamento preto



QAR1457PT

Spine

Estrutura: Metal

Acabamento: Preto, Cobre ou Dourado



● **QPD1361DO**
Pendente

6 x E27 | 40W
Dimensões: C700 x L165 x A220 mm
Tensão: Bivolt (127V/220V)
Potência máxima: 240W
Cabo ajustável até 1500 mm



QPD1361PT
Acabamento preto



QPD1361CO
Acabamento cobre

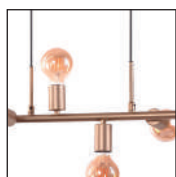

QPD1361DO
Acabamento dourado



QPD1361CO

Arrow

Estrutura: Metal

Acabamento: Preto ou Marrom



● **PD1310-CA**
Pendente

6x E27 40W
Dimensões: Ø500 x A510 mm
Tensão: Bivolt (127V/220V)
Potência máxima: 240W
Cabo ajustável até 1500 mm



PD1310-CA
Acabamento marrom/
detalhe cobre



PD1310-PT
Acabamento preto/
detalhe dourado



PD1310-CA

Cluster

Estrutura: Metal

Acabamento: Preto ou Dourado
| Fio transparente



QPD13229DO



● **QPD13224**

Pendente

4 x E27 | 40W

Dimensões: Ø400 x A300 mm

Tensão: Bivolt (127V/220V)

Potência máxima: 160W

Cabo ajustável até 1500 mm



● **QPD13229**

Pendente

9 x E27 | 40W

Dimensões: Ø660 x A530 mm

Tensão: Bivolt (127V/220V)

Potência máxima: 360W

Cabo ajustável até 1500 mm



QPD13224

Acabamento preto



QPD13224DO

Acabamento dourado
Cabo transparente



QPD13229

Acabamento preto

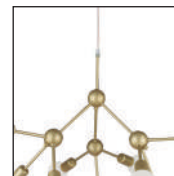

QPD13229DO

Acabamento dourado
Cabo transparente

Torch

Estrutura: Metal

Acabamento: Preto com detalhe em cobre ou preto com detalhe em dourado

Não acompanha a lâmpada



● **QAR1349**

Arandela

1 x E27 | 40W

Dimensões: C110 x L110 x A195 mm

Tensão: Bivolt (127V/220V)

Potência máxima: 40W



QAR1349

Acabamento preto/
detalhe cobre

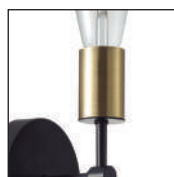

QAR1349DO

Acabamento preto/
detalhe dourado



QAR1349

Trace

Estrutura: Metal

Acabamento: Preto com detalhes em cobre ou preto com detalhes em dourado

Não acompanha as lâmpadas



QAR1351



● **QAR1350**

Arandela

2 x E27 | 40W

Dimensões: C225 x L110 x A320 mm

Tensão: Bivolt (127V/220V)

Potência máxima: 80W



QAR1350

Acabamento preto/
detalhe cobre



QAR1350DO

Acabamento preto/
detalhe dourado



● **QAR1351**

Arandela

1 x E27 | 40W

Dimensões: C140 x L120 x A220 mm

Tensão: Bivolt (127V/220V)

Potência máxima: 40W



QAR1351

Acabamento preto/
detalhe cobre



QAR1351DO

Acabamento preto/
detalhe dourado

Kiev

Estrutura: Metal

Acabamento: Preto com detalhes em cobre



● **QPL13154**

Plafon

4 x E27 | 40W

Dimensões: C320 x L210 x A140 mm

Tensão: Bivolt (127V/220V)

Potência máxima: 160W



● **QPD131412**

Pendente

12 x E27 | 40W

Dimensões: Ø430 x A310 mm

Tensão: Bivolt (127V/220V)

Potência máxima: 480W

Cabo ajustável até 1500 mm



● **QPD131418**

Pendente

18 x E27 | 40W

Dimensões: Ø545 x A515 mm

Tensão: Bivolt (127V/220V)

Potência máxima: 720W

Cabo ajustável até 1500 mm



QPD131412

Globe

Estrutura: Metal

Acabamento: Preto com detalhe em cobre



● **PD1138**
Pendente

1 x E27 | 40W
Dimensões: Ø300 x A320 mm
Tensão: Bivolt (127V/220V)
Potência máxima: 40W
Cabo ajustável até 1500 mm



PD1139



● **PD1139**
Pendente

1 x E27 | 40W
Dimensões: Ø400 x A420 mm
Tensão: Bivolt (127V/220V)
Potência máxima: 40W
Cabo ajustável até 1500 mm



● **PD1140**
Pendente

1 x E27 | 40W
Dimensões: Ø500 x A520 mm
Tensão: Bivolt (127V/220V)
Potência máxima: 40W
Cabo ajustável até 1500 mm

Tine

Estrutura: Metal

Acabamento: Preto com detalhes em cobre



PD644



● **PD644**
Pendente

3 x E27 | 40W
Dimensões: C550 x L190 x A180 mm
Tensão: Bivolt (127V/220V)
Potência máxima: 120W
Cabo ajustável até 1500 mm



● **PD645**
Pendente

5 x E27 | 40W
Dimensões: C920 x L200 x A200 mm
Tensão: Bivolt (127V/220V)
Potência máxima: 200W
Cabo ajustável até 1500 mm

Ivory

Estrutura: Metal

Acabamento: Preto com detalhes em cobre



● **PD642**
Pendente

1 x E27 | 40W
Dimensões: L200 x A200 mm
Tensão: Bivolt (127V/220V)
Potência máxima: 40W
Cabo ajustável até 1500 mm



● **PD643**
Pendente

6 x E27 | 40W
Dimensões: L500 x A800 mm
Tensão: Bivolt (127V/220V)
Potência máxima: 240W
Cabo ajustável até 1500 mm



PD643

Nice

Estrutura: Metal

Acabamento: Preto ou Cobre



● **QPD919-CO**

Pendente

1 x E27 | 40W

Dimensões: Ø150 x A200 mm

Tensão: Bivolt (127V/220V)

Potência máxima: 40W

Cabo ajustável até 1500 mm



QPD919-CO
Acabamento cobre



QPD919-PT
Acabamento preto



QPD919-PT

Manner

Estrutura: Metal
Acabamento: Preto

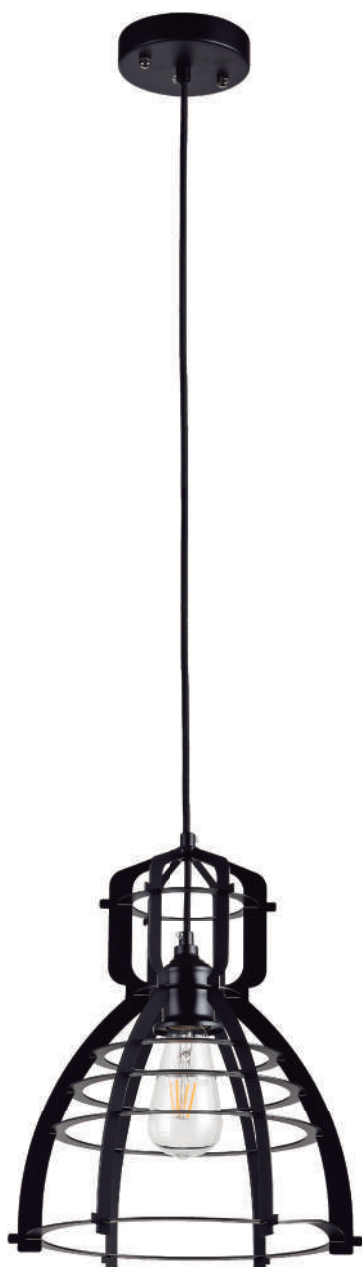

PD852

● **PD852**
Pendente

1 x E27 | 40W
Dimensões: Ø295 x A350 mm
Tensão: Bivolt (127V/220V)
Potência máxima: 40W
Cabo ajustável até 1500 mm

Lockup

Estrutura: Metal e Concreto

Acabamento: Preto



● **PD706**
Pendente

1 x E27 | 40W
Dimensões: Ø125 x A390 mm
Tensão: Bivolt (127V/220V)
Potência máxima: 40W
Cabo ajustável até 1500 mm



● **PD707**
Pendente

1 x E27 | 40W
Dimensões: Ø260 x A300 mm
Tensão: Bivolt (127V/220V)
Potência máxima: 40W
Cabo ajustável até 1500 mm



PD707

Jubile

Estrutura: Metal e Concreto

Acabamento: Cobre



● **PD1127**
Pendente

1 x E27 | 40W
Dimensões: Ø180 x A195 mm
Tensão: Bivolt (127V/220V)
Potência máxima: 40W
Cabo ajustável até 1500 mm



● **PD1128**
Pendente

1 x E27 | 40W
Dimensões: Ø300 x A220 mm
Tensão: Bivolt (127V/220V)
Potência máxima: 40W
Cabo ajustável até 1500 mm



PD1128

Sling

Estrutura: Concreto

Acabamento: Concreto



● **PD709**
Pendente

1 x E27 | 40W
Dimensões: Ø160 x A180 mm
Tensão: Bivolt (127V/220V)
Potência máxima: 40W
Cabo ajustável até 1500 mm



PD709

Somut

Estrutura: Metal/ Concreto

PD1748: Concreto / Vidro

PD1756: Metal/ Concreto/ Acrílico



● **PD1756**
Pendente

1xG9 LED 5W
Dimensões: Ø130 x A135 mm
Tensão: Bivolt (127V/220V)
Potência máxima: 5W
Cabo ajustável até 2000 mm



● **PD1612**
Pendente

LED 4W
Lúmens: 300lm
Temperatura: 3000K
Dimensões: Ø45 x A400 mm
Tensão: Bivolt (127V/220V)
Potência máxima: 4W
Cabo ajustável até 1500 mm



● **PD1748**

Pendente

1xG9 LED 5W
Dimensões: Ø80 x A150 mm
Tensão: Bivolt (127V/220V)
Potência máxima: 5W
Cabo ajustável até 1500 mm



● **PD1613**

Pendente

LED 4W
Lúmens: 300lm
Temperatura: 3000K
Dimensões: Ø70 mm
Tensão: Bivolt (127V/220V)
Potência máxima: 4W
Cabo ajustável até 1500 mm



PD1613

Cover

Estrutura: Madeira ou Concreto
Acabamento: Madeira ou Concreto
Cabo: Preto



● **PD750**
Pendente

1 x E27 | 40W
Dimensões: Ø45 x A90 mm
Tensão: Bivolt (127V/220V)
Potência máxima: 40W
Cabo ajustável até 1500 mm



● **PD751**
Pendente

1 x E27 | 40W
Dimensões: Ø45 x A90 mm
Tensão: Bivolt (127V/220V)
Potência máxima: 40W
Cabo ajustável até 1500 mm

Halter

Estrutura: Corda

Acabamento: Natural



● **PD712**
Pendente

1 x E27 | 40W
Dimensões: Ø35 x A1500 mm
Tensão: Bivolt (127V/220V)
Potência máxima: 40W
Cabo ajustável até 1500 mm

Post

Estrutura: Metal/ base de mármore/
cúpula de tecido
Cúpula: Tecido preto
Acabamento: Preto



● **CL1024**
Coluna

1xE27 40W
Dimensões: C500 x L1630 x A1980 mm
Cúpula: Ø360 / Ø490 x A260 mm
Tensão: Bivolt (127V/220V)
Potência máxima: 40W
Possui cabo com interruptor liga e desliga para ser ligado a tomada



CL1024

Fita

Metal | Silicone | Preto ou Dourado

LANÇAMENTO • 2023

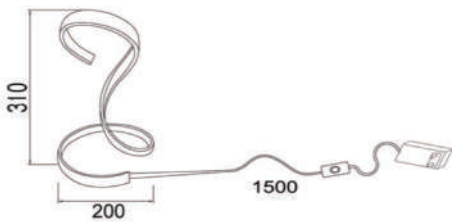

Possui cabo com interruptor liga e desliga para ser ligado a tomada



● **AB1775PT**
Abajur

1XLED | 15W | 1200LM | 3000K
D200XA310mm
Bivolt



● **AB1775DO**
Abajur

1XLED | 15W | 1200LM | 3000K
D200XA310mm
Bivolt

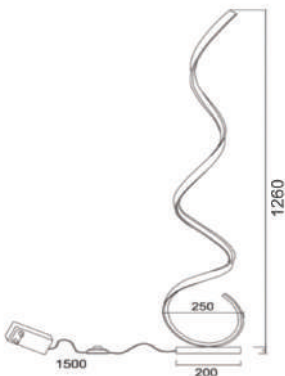

Possui cabo com interruptor liga e desliga para ser ligado a tomada



● **CL1776PT**
Coluna

1XLED | 24W | 1920LM | 3000K
D250XA1260mm
Bivolt



● **CL1776DO**
Coluna

1XLED | 24W | 1920LM | 3000K
D250XA1260mm
Bivolt

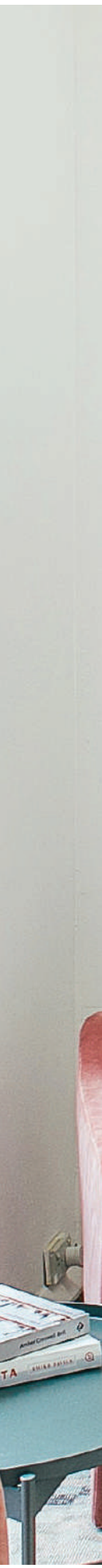



CL177600

Onda

Metal e Alumínio | Silicone | Preto, Branco ou Dourado

ACOMPANHA CABO USB COM INTERRUPTOR LIGA/ DESLIGA DIMERIZÁVEL.

NÃO ACOMPANHA CARREGADOR (FONTE USB 5V).

LANÇAMENTO • 2023



● **AB1803BR**
Abajur

1XLED | 5,6W | 200LM | 3000K
D120XA380mm
Bivolt
Dimerizável

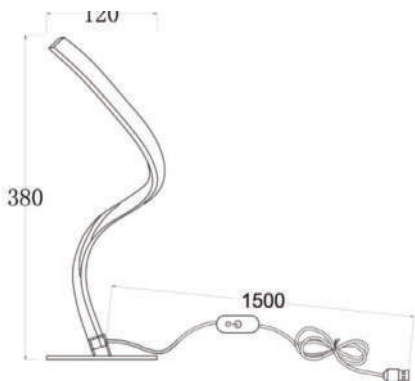

Possui cabo com interruptor liga e desliga para ser ligado a tomada



● **AB1803PT**
Abajur

1XLED | 5,6W | 200LM | 3000K
D120XA380mm
Bivolt
Dimerizável



AB1803DO



● **AB1803DO**

Abajur

1XLED | 5,6W MAX | 200LM | 3000K
D120XA380mm
Bivolt
Dimerizável

Krio

Estrutura: Alumínio
Acabamento: Preto, Dourado ou Branco



● **AB1763PT**
Abajur

2x G9 LED 5W
Dimensões: Ø250 x A365 mm
Tensão: Bivolt (127V/220V)
Potência máxima: 10W
Possui cabo com interruptor liga e desliga para ser ligado a tomada

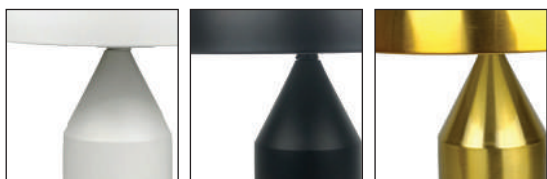

AB1763BR
acabamento branco

AB1763PT
acabamento preto

AB1763DO
acabamento dourado

Orla

Estrutura: Alumínio / Vidro
Difusor: Branco opalino
Acabamento: Preto, Dourado ou Branco

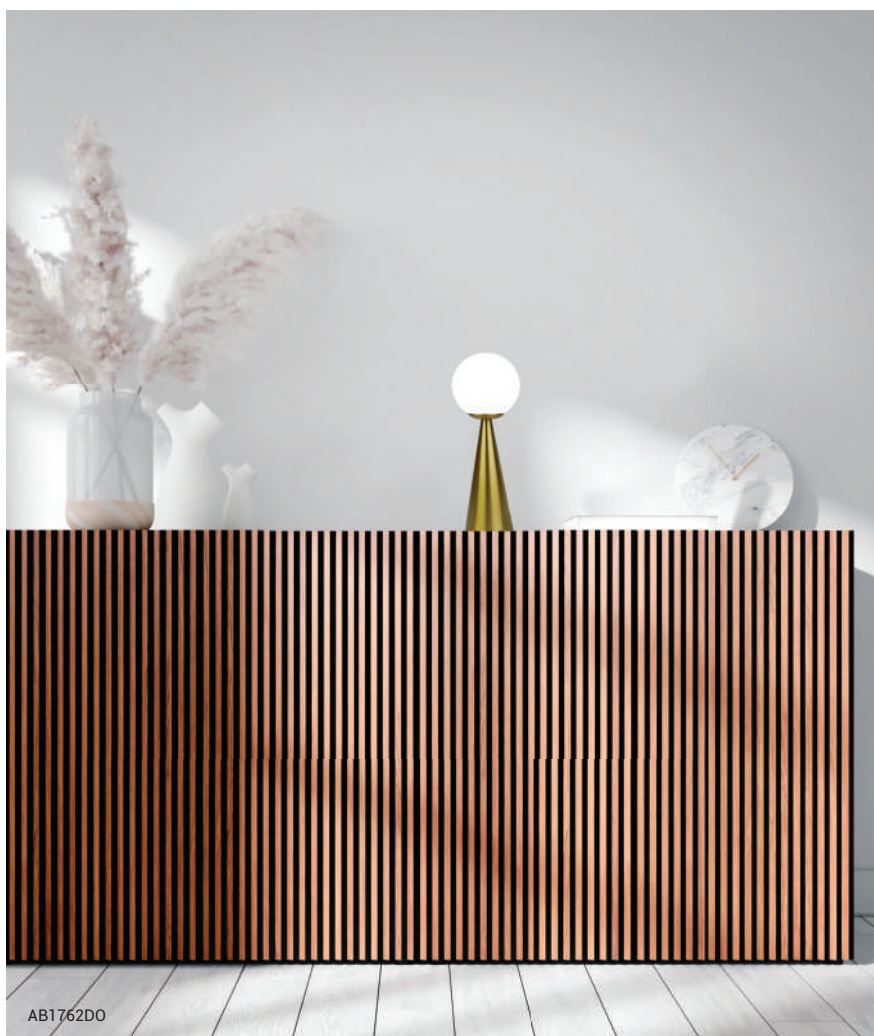

● AB1762PT

Abajur

1x G9 5W

Dimensões: Ø150 x A405 mm

Tensão: Bivolt (127V/220V)

Potência máxima: 5W

Possui cabo com interruptor liga e desliga para ser ligado a tomada



AB1762BR

AB1762PT

AB1762DO

Mizo

Estrutura: Policarbonato
Acabamento: Preto ou Branco

Acendimento e dimerização por touch,
Acompanha cabo USB para recarregar,
Direcionável



● **AB1766BR**
Abajur

LED 4W
Voltagem: 5V
Lúmens: 400lm
Temperatura: 3000K - dimerizável touch
Dimensões: Ø140 x A218 mm
Tensão: USB-DC 5V
Potência máxima: 4W



AB1766BR
acabamento branco

AB1766PT
acabamento preto

AB1766DO
acabamento dourado



Carregamento por USB

Kono

Estrutura: Alumínio/Acrílico/ Silicone
Acabamento: Branco ou Cromada

Liga e Desliga ao toque (touch)
Acompanha cabo USB



● **AB1741CR**
Abajur

LED 2x 2,5W
Voltagem: 5V
Lúmens: 400lm
Temperatura: RGB Dimerizável
Dimensões: Ø150 C110 x L110 x A390 mm
Tensão: USB-DC 5V
Potência máxima: 5W
Recarregável por USB



AB1741BR



AB1741CR



Mimo

Metal | Pc | Preto, Branco ou Dourado

ACOMPANHA CABO USB
NÃO ACOMPANHA CARREGADOR

LANÇAMENTO • 2023

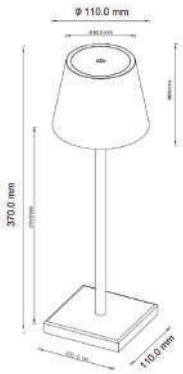

● **AB1788PT**
Abajur

1XLED | 3,5W | 280LM | 3000K
D110XA370mm
Bateria Interna - USB-5V
Dimerizável touch



● **AB1788DO**
Abajur

1XLED | 3,5W | 280LM | 3000K
D110XA370mm
Bateria Interna - USB-5V
Dimerizável touch



● **AB1788BR**
Abajur

1XLED | 3,5W | 280LM | 3000K
D110XA370mm
Bateria Interna - USB-5V
Dimerizável touch



AB1788BR

Deja Vu

Acrílico | Transparente



Detalhe da peça

ACOMPANHA CABO USB E
CONTROLE REMOTO
NÃO ACOMPANHA CARREGADOR

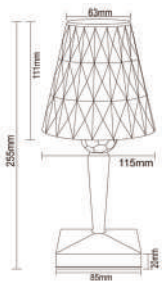

● **AB1785**
Abajur

1XLED | 1W MAX | 90LM | RGBW
D115XA255mm
Bateria Interna - USB-3,7V-5V



AB1785

Auê

Abs | Acrílico | Dourado ou Branco

LANÇAMENTO • 2023



Detalhe da peça

ACOMPANHA CABO USB E
CONTROLE REMOTO
NÃO ACOMPANHA CARREGADOR



● **AB1786DO**

Abajur

1XLED | 1W | 90LM | RGBW
D120XA232mm
Bateria Interna - USB-3,7V-5V



● **AB1786BR**

Abajur

1XLED | 1W | 90LM | RGBW
D120XA232mm
Bateria Interna - USB-3,7V-5V

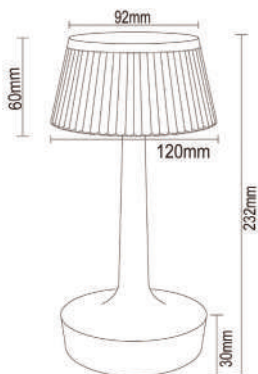



AB1786BR

Dengo

Metal | Ps | Bronze, Preto ou Branco

LANÇAMENTO • 2023



3000K - Branco Quente

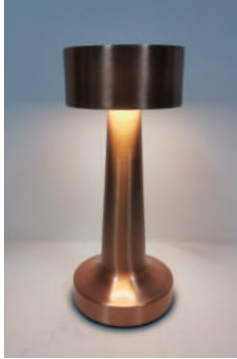

4500K - Branco Neutro



6000K - Branco Frio

ACOMPANHA CABO USB E
NÃO ACOMPANHA CARREGADOR

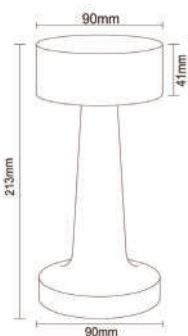
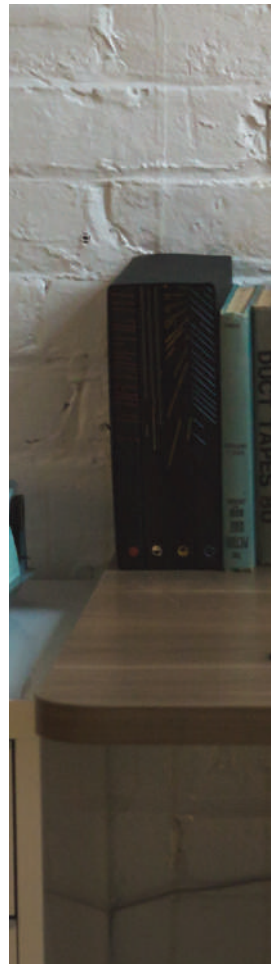

● **AB1787PT**
Abajur

1XLED | 3W | 270LM | 3000K/4500K/6000K
D90XA213mm
Bateria Interna - USB-3,7V-5V
Dimerizável touch



● **AB1787DO**
Abajur

1XLED | 3W | 270LM | 3000K/4500K/6000K
D90XA213mm
Bateria Interna - USB-3,7V-5V
Dimerizável touch



● **AB1787BR**
Abajur

1XLED | 3W | 270LM | 3000K/4500K/6000K
D90XA213mm
Bateria Interna - USB-3,7V-5V
Dimerizável touch



AB1787PT

Mia

Metal | Acrílico | Dourado ou Preto



Detalhe do difusor



Detalhe da base

ACOMPANHA CABO USB
NÃO ACOMPANHA CARREGADOR

LANÇAMENTO • 2023



● **AB1821DO**

Abajur

1XLED | 3W | 270LM | 3000K/4500K/6000K
D130XA283mm
Bateria Interna - USB-3,7V-5V
Dimerizável touch



● **AB1821PT**

Abajur

1XLED | 3W | 270LM | 3000K/4500K/6000K
D130XA283mm
Bateria Interna - USB-3,7V-5V
Dimerizável touch

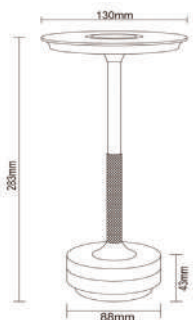

Zuzu

Metal | Silicone | Preto ou Branco

ACOMPANHA CABO USB COM INTERRUPTOR TOUCH DIMERIZÁVEL.

NÃO ACOMPANHA CARREGADOR (FONTE USB 5V).



● **AB1854PT**
Abajur

1XLED | 8W | 720LM | 3000K
D280XA360mm
Bateria Interna - USB-3,7V-5V



● **AB1854BR**
Abajur

1XLED | 8W | 720LM | 3000K
D280XA360mm
Bateria Interna - USB-3,7V-5V

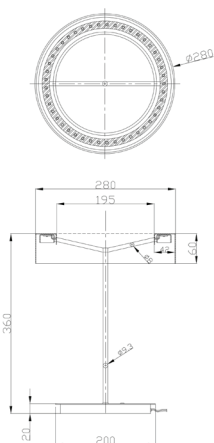

Poti

Madeira | Tecido | Amadeirado e Branco

CÚPULA INCLUSA

LANÇAMENTO • 2023

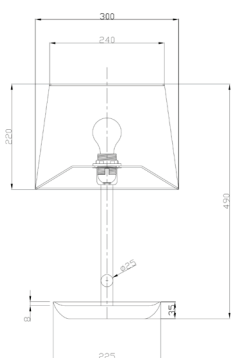

● **AB1855MD**
Abajur

1XE27 | 40W MAX
D300XA485mm
Bivolt

Possui cabo com interruptor liga e desliga para ser ligado a tomada



AB1855MD



Flint

Estrutura: Metal/cúpula de vidro

Difusor: Cúpula champagne /

Cúpula fumê

Acabamento: Preto ou Dourado



● **QAB1335FM**

Abajur

1xE27 40W (lâmpada LED de filamento)
Dimensões: Ø160 xA285 mm
Tensão: Bivolt (127V/220V)
Potência máxima: 40W
Possui cabo com interruptor liga e desliga para ser ligado a tomada



● **QAB1335CH**

Abajur

1xE27 40W (lâmpada LED de filamento)
Dimensões: Ø160 xA285 mm
Tensão: Bivolt (127V/220V)
Potência máxima: 40W
Possui cabo com interruptor liga e desliga para ser ligado a tomada

Tint

Estrutura: Concreto
 Cúpula (QAB1374): Tecido
 Acabamento: Base cinza com detalhe em cobre ou Base preta com detalhe em dourado

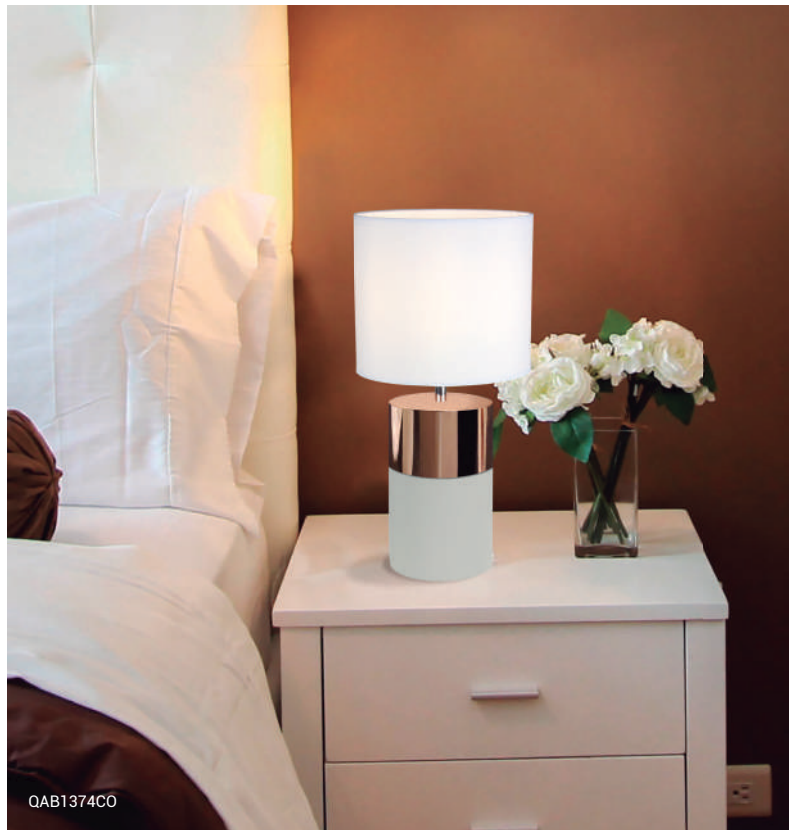

QAB1374CO



● **QAB1375CO**
 Abajur

1 x E27 | 40W
 Dimensões: Ø90 x A120 mm
 Tensão: Bivolt (127V/220V)
 Potência máxima: 40W
 Possui cabo com interruptor liga e desliga para ser ligado a tomada



QAB1375CO
 Base cinza
 Detalhe cobre

QAB1375DO
 Base preta
 Detalhe dourado



● **QAB1374DO**
 Abajur

1 x E27 | 40W
 Dimensões: Ø180 x A371 mm
 Tensão: Bivolt (127V/220V)
 Potência máxima: 40W
 Possui cabo com interruptor liga e desliga para ser ligado a tomada



QAB1374CO
 Base cinza
 detalhe cobre
 cúpula branca

QAB1374DO
 Base preta
 detalhe dourado
 cúpula preta

Potter

Estrutura: Cerâmica

Cúpula: Branco ou Preto



● **QAB1454PT**

Abajur

1 x E27 | 40W

Dimensões: Ø150 x A320 mm

Tensão: Bivolt (127V/220V)

Potência máxima: 40W

Possui cabo com interruptor liga e desliga para ser ligado a tomada



QAB1454BR



QAB1454PT





QAR1454BR

Tack

Estrutura: Metal / Cúpula tecido

Cúpula: Branco / Preto

Acabamento: Dourado / Níquel / Preto



● **QAB1066-DO**

Abajur

1 x E27 | 40W

Dimensões: Ø160 x A290 mm

Tensão: Bivolt (127V/220V)

Potência máxima: 40W

Possui cabo com interruptor liga e desliga para ser ligado a tomada



● **QAB1067-BR**

Abajur

1 x E27 | 40W

Dimensões: Ø160 x A290 mm

Tensão: Bivolt (127V/220V)

Potência máxima: 40W

Possui cabo com interruptor liga e desliga para ser ligado a tomada



QAB1067-BR
Acabamento níquel /
cúpula branca

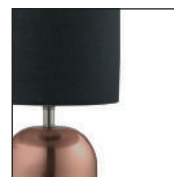

QAB1067-PT
Acabamento cobre /
cúpula preto



QAB1066-DO
Acabamento dourado/
cúpula preto

Turret

Estrutura: Metal / Cúpula de tecido

Cúpula: Branco ou Preto

Acabamento: Base dourada,

Base níquel ou Base cobre



QAB1069-BR



● **QAB1068-DO**

Abajur

1 x E27 | 40W

Dimensões: Ø200 x A365 mm

Tensão: Bivolt (127V/220V)

Potência máxima: 40W

Possui cabo com interruptor liga e desliga para ser ligado a tomada



● **QAB1069-BR**

Abajur

1 x E27 | 40W

Dimensões: Ø200 x A365 mm

Tensão: Bivolt (127V/220V)

Potência máxima: 40W

Possui cabo com interruptor liga e desliga para ser ligado a tomada



QAB1069-BR

Acabamento níquel /
cúpula branca



QAB1069-PT

Acabamento cobre /
cúpula preta



QAB1068-DO

Acabamento dourado /
cúpula preta

Sicília

Estrutura: Cerâmica/ Cúpula tecido

Cúpula: Bege ou Preta

Acabamento: Bege ou Preta



● QAB914-PT

Abajur

1 x E27 | 40W

Dimensões: Ø150 x A300 mm

Tensão: Bivolt (127V/220V)

Potência máxima: 40W

Possui cabo com interruptor liga e desliga para ser ligado a tomada



QAB914-PT



QAB914-BG
Acabamento bege



QAB914-PT
Acabamento preto

Verona

Estrutura: Cerâmica / Cúpula de tecido

Cúpula: Bege ou Preto

Acabamento: Base bege ou Base preta



● **QAB916-BG**

Abajur

1 x E27 | 40W

Dimensões: Ø160 x A330 mm

Tensão: Bivolt (127V/220V)

Potência máxima: 40W

Possui cabo com interruptor liga e desliga para ser ligado a tomada



QAB916-BG

Acabamento bege



QAB916-PT

Acabamento preto



QAB916-PT

Bases de Abajur

CÚPULAS VENDIDAS SEPARADAMENTE

Indira

Madeira e Metal | Amadeirado e Dourado ou Preto

LANÇAMENTO • 2023



CUP001PT
Cúpula

- **BA019MD**
Base De Abajur
1XE27 | 40W MAX
D120XA495mm
Bivolt

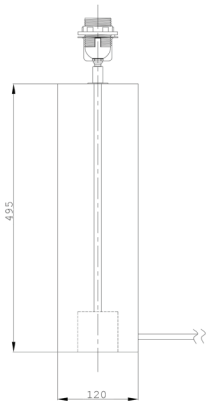

Possui cabo com interruptor liga e desliga para ser ligado a tomada



CUP001FD
Cúpula

- **BA019PT**
Base De Abajur
1XE27 | 40W MAX
D120XA495mm
Bivolt



BA019PT + CUP001FD

Bases de Abajur

CÚPULAS VENDIDAS SEPARADAMENTE

Kon

Madeira e Metal | Amadeirado e Dourado

LANÇAMENTO • 2023



CUP004BG
Cúpula

● **BA018MD**
Base De Abajur

1XE27 | 40W MAX
D150XA550mm
Bivolt

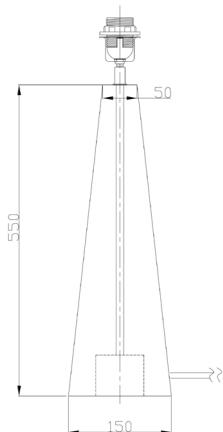

Possui cabo com interruptor liga e desliga para ser ligado a tomada



CUP001BR
Cúpula

● **BA018PT**
Base De Abajur

1XE27 | 40W MAX
D150XA550mm
Bivolt





BA018PT + CUP004BG

Bases de Abajur

CÚPULAS VENDIDAS SEPARADAMENTE



CUP001BR
Cúpula

● **BA001CR**
Abajur

1x E27 40W
Dimensões: 110 x A470 mm
Acabamento: cromado
Tensão: Bivolt (127V/220V)
Potência máxima: 40W
Possui cabo com interruptor liga e desliga para ser ligado a tomada



CUP004PT
Cúpula

● **BA001DO**
Abajur

1x E27 40W
Dimensões: 110 x A470 mm
Acabamento: dourado
Tensão: Bivolt (127V/220V)
Potência máxima: 40W
Possui cabo com interruptor liga e desliga para ser ligado a tomada



CUP004BG
Cúpula



CUP001BR
Cúpula

● **BA002**
Abajur

1x E27 40W
Dimensões: 160 x A500 mm
Tensão: Bivolt (127V/220V)
Potência máxima: 40W
Possui cabo com interruptor liga e desliga para ser ligado a tomada



CUP001BG
Cúpula

● **BA010**
Abajur

1x E27 40W
Dimensões: 120 x A480 mm
Tensão: Bivolt (127V/220V)
Potência máxima: 40W
Possui cabo com interruptor liga e desliga para ser ligado a tomada

Bases de Abajur

CÚPULAS VENDIDAS SEPARADAMENTE



CUP004BR
Cúpula



CUP003FD
Cúpula

● **BA003**
Abajur

1x E27 40W
Dimensões: 120 x L120 x A420 mm
Acabamento: Mármore preto
Tensão: Bivolt (127V/220V)
Potência máxima: 40W
Possui cabo com interruptor liga e desliga para ser ligado a tomada



CUP003BG
Cúpula



BA004 / CUP003BG

● **BA004**
Abajur

1x E27 40W
Dimensões: 220 x L120 x A440 mm
Acabamento: Mármore preto
Tensão: Bivolt (127V/220V)
Potência máxima: 40W
Possui cabo com interruptor liga e desliga para ser ligado a tomada



CUP004PT
Cúpula

Bases de Abajur

CÚPULAS VENDIDAS SEPARADAMENTE



CUP002FD
Cúpula



CUP003BG
Cúpula

● **BA005**
Abajur

1x E27 40W
Dimensões: 280 x L120 x A320 mm
Tensão: Bivolt (127V/220V)
Potência máxima: 40W
Possui cabo com interruptor liga e desliga para ser ligado a tomada



CUP002BG
Cúpula



CUP004FD
Cúpula

● **BA006**
Abajur

1x E27 40W
Dimensões: 150 x L150 x A550 mm
Tensão: Bivolt (127V/220V)
Potência máxima: 40W
Possui cabo com interruptor liga e desliga para ser ligado a tomada



Bases de Abajur

CÚPULAS VENDIDAS SEPARADAMENTE



CUP001FD
Cúpula



CUP002PT
Cúpula

● **BA007**
Abajur

1x E27 40W
Dimensões: 280 x L120 x A320 mm
Tensão: Bivolt (127V/220V)
Potência máxima: 40W
Possui cabo com interruptor liga e desliga para ser ligado a tomada



CUP004FD
Cúpula



CUP001BG
Cúpula

● **BA008**
Abajur

1x E27 40W
Dimensões: 120 x A520 mm
Tensão: Bivolt (127V/220V)
Potência máxima: 40W
Possui cabo com interruptor liga e desliga para ser ligado a tomada

Bases de Abajur

CÚPULAS VENDIDAS SEPARADAMENTE



CUP002PT
Cúpula



CUP003FD
Cúpula

● **BA009**
Abajur

1x E27 40W
Dimensões: 120 x L100 x A470 mm
Tensão: Bivolt (127V/220V)
Potência máxima: 40W
Possui cabo com interruptor liga e desliga para ser ligado a tomada



CUP001BG
Cúpula



CUP003PT
Cúpula

● **BA011**
Abajur

1x E27 40W
Dimensões: 250 x L100 x A460 mm
Tensão: Bivolt (127V/220V)
Potência máxima: 40W
Possui cabo com interruptor liga e desliga para ser ligado a tomada

Bases de Abajur

CÚPULAS VENDIDAS SEPARADAMENTE



CUP001PT
Cúpula

● **BA012**
Abajur

1x E27 40W
Dimensões: 180 x L130 x A527 mm
Material: Cristal
Tensão: Bivolt (127V/220V)
Potência máxima: 40W
Possui cabo com interruptor liga e desliga para ser ligado a tomada



CUP004BR
Cúpula



CUP003BG
Cúpula



CUP004PT
Cúpula

● **BA013**
Abajur

1x E27 40W
Dimensões: 180 x L130 x A527 mm
Material: Cristal
Tensão: Bivolt (127V/220V)
Potência máxima: 40W
Possui cabo com interruptor liga e desliga para ser ligado a tomada

Bases de Abajur

CÚPULAS VENDIDAS SEPARADAMENTE



CUP002BR
Cúpula



CUP001PT
Cúpula

● **BA015**
Abajur

1x E27 40W
Dimensões: 100 x A395 mm
Material: Cristal
Tensão: Bivolt (127V/220V)
Potência máxima: 40W
Possui cabo com interruptor liga e desliga para ser ligado a tomada



CUP001FD
Cúpula



CUP004BR
Cúpula

● **BA016**
Abajur

1x E27 40W
Dimensões: 140 x A430 mm
Material: Cristal
Tensão: Bivolt (127V/220V)
Potência máxima: 40W
Possui cabo com interruptor liga e desliga para ser ligado a tomada

Bases de Abajur

CÚPULAS VENDIDAS SEPARADAMENTE



CUP001FD
Cúpula



CUP002PT
Cúpula

● **BA017**
Abajur

1x E27 40W
Dimensões: 120 x A424 mm
Material: Cristal
Tensão: Bivolt (127V/220V)
Potência máxima: 40W
Possui cabo com interruptor liga e desliga
para ser ligado a tomada



BA017 / CUP002PT

Cúpuas de Abajur



Rustic

LANÇAMENTO • 2023

CUP006

Cúpula Cilíndrica

Material: Fibra

Dimensões: 400 x 400 x 300 mm



CUP001BR

CUP001PT

CUP001BG

CUP001FD

CUP001

Cúpula Cilíndrica

Material: Tecido

Dimensões: 400 x 400 x 300 mm



CUP002BR

CUP002PT

CUP002BG

CUP002FD

CUP002

Cúpula Cilíndrica

Material: Tecido

Dimensões: 300 x 300 x 330 mm



CUP003

Cúpula Retangular

Material: Tecido

Dimensões: 400 x 230 x 300 mm



CUP003BR

CUP003PT

CUP003BG

CUP003FD



CUP004

Cúpula Cônica

Material: Tecido

Dimensões: 420 x 340 x 310 mm



CUP004BR

CUP004PT

CUP004BG

CUP004FD

Canopla Slim para Gesso

Fácil instalação, proporciona um ambiente clean e permite maior variedade em suas composições. Para a instalação, é necessária a desmontagem do produto original e alocar o driver no teto, permanecendo embutido no gesso.



- CAN009DO
- CAN009PT
Ø55 mm

Compatíveis com:

- PD1508PT / PD1508DO
- PD1488DO / PD1488PT
- PD1475
- PD1494 / PD1495

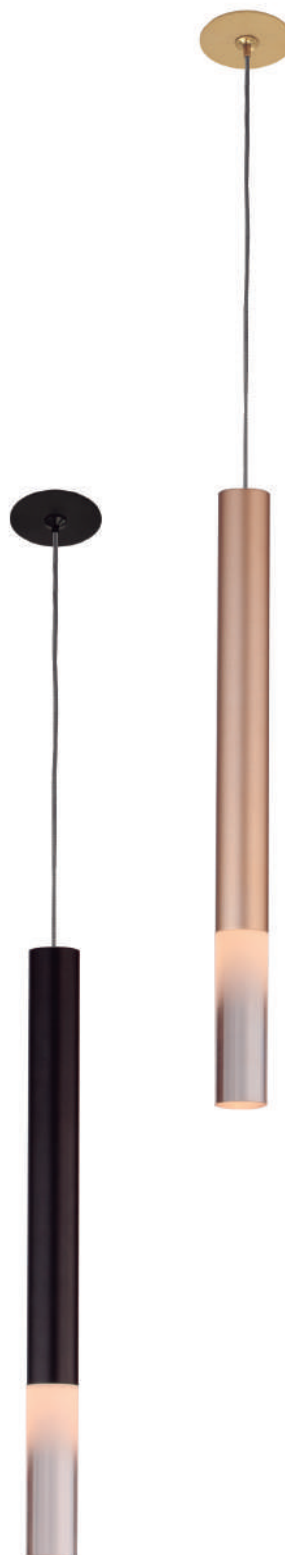



PD1508PT

INDEX

por referência

606	355	AR977	365	AR1606PT	372
609	355	AR977PT	365	AR1628BR	156
617	355	AR978	366	AR1628DO	156
AB1378BZ	335	AR978PT	366	AR1628PT	156
AB1378BZ-BR	335	AR1157-BR	389	AR1640DO	323
AB1422	311	AR1157-PT	389	AR1640PT	323
AB1631BR	157	AR1264	252	AR1646DO	141
AB1631DO	157	AR1302-BR	378	AR1646PT	141
AB1631PT	157	AR1302-PR	378	AR1647DO	141
AB1672BR	256	AR1302-PT	378	AR1647PT	141
AB1672DO	256	AR1332BZ	334	AR1653BR	217
AB1672PT	256	AR1332BZ-BR	334	AR1653DO	217
AB1685DO	120	AR1332PT	334	AR1653PT	217
AB1685OX	120	AR1332PT-BR	334	AR1655BR	217
AB1720DO	325	AR1346	336	AR1655DO	217
AB1720PT	325	AR1346BR	336	AR1655PT	217
AB1736DO	330	AR1380CR	349	AR1657DO	161
AB1736OX	330	AR1380DO	349	AR1660	56
AB1741BR	428	AR1382CH	347	AR1669BR	211
AB1741CR	428	AR1402	163	AR1669DO	211
AB1762BR	426	AR1409	49	AR1669PT	211
AB1762DO	426	AR1409BR	49	AR1670BR	253
AB1762PT	426	AR1421	311	AR1670DO	253
AB1763BR	425	AR1426BR	206	AR1670PT	253
AB1763DO	425	AR1426CO	206	AR1671BR	254
AB1763PT	425	AR1426DO	206	AR1671DO	254
AB1766BR	427	AR1426PT	206	AR1671PT	254
AB1766DO	427	AR1428BR	376	AR1676	41
AB1766PT	427	AR1428PT	376	AR1689BR	215
AB1775DO	421	AR1433	348	AR1689DO	215
AB1775PT	421	AR1445BR	377	AR1689PT	215
AB1785	430	AR1445PT	377	AR1690BR	216
AB1786BR	431	AR1447BR	379	AR1690DO	216
AB1786DO	431	AR1447PT	379	AR1690PT	216
AB1787BR	434	AR1450	314	AR1696	11
AB1787DO	434	AR1456	37	AR1703	239
AB1787PT	433	AR1456DO	37	AR1709	35
AB1788BR	429	AR1459	259	AR1717DO	67
AB1788DO	429	AR1462	341	AR1718DO	67
AB1788PT	429	AR1468	43	AR1719DO	357
AB1803BR	423	AR1476	53	AR1719PT	357
AB1803DO	424	AR1487	126	AR1722	134
AB1803PT	423	AR1500A	139	AR1726DO	287
AB1816FD	224	AR1500ADO	139	AR1726PT	287
AB1816PT	224	AR1504	165	AR1727DO	287
AB1821DO	435	AR1507	134	AR1727PT	287
AB1821PT	435	AR1511	70	AR1770	34
AB1838DOMD	150	AR1513DO	261	AR1771	34
AB1838PTMD	150	AR1513PT	261	AR1783	25
AB1854BR	436	AR1515	46	AR1798DO	169
AB1854PT	436	AR1600	145	AR1798PT	169
AB1855MD	437	AR1600DO	145	AR1804	21
AR803	380	AR1605	372	AR1824	85
AR804	380	AR1605PT	372	AR1828	89
AR862-MR	383	AR1606	372	AR1834DOMD	149

AR1834PTMD	149	CAN008	125	LM1603	371
AR1869	101	CAN009DO	469	LM1603PT	371
ARH1535CHDO	269	CAN009PT	469	LM1702	239
ARH1535CHPT	269	CL861-BR	384	LMSH1574DO	73
ARH1535DO	269	CL861-PT	384	LMSH1574PT	73
ARH1535PT	269	CL1024	419	LT638	352
ARH1535TRDO	269	CL1490	148	LT638-DO	352
ARH1535TRPT	269	CL1490DO	148	PD622	349
ARH1536CHDO	281	CL1493	113	PD622-DO	349
ARH1536CHPT	281	CL1602	148	PD643	407
ARH1536DO	281	CL1602DO	148	PD644	406
ARH1536PT	281	CL1604	371	PD645	406
ARH1536TRDO	281	CL1604PT	371	PD706	411
ARH1536TRPT	281	CL1630BR	157	PD707	411
ARH1560CHDO	285	CL1630DO	157	PD709	414
ARH1560CHPT	285	CL1630PT	157	PD712	418
ARH1560DO	285	CL1673BR	255	PD750	417
ARH1560PT	285	CL1673DO	255	PD751	417
ARH1560TRDO	285	CL1673PT	255	PD852	410
ARH1560TRPT	285	CL1687DO	121	PD947-CO	364
ARH1585DO	63	CL1687OX	121	PD947-CR	364
ARH1585PT	63	CL1704	239	PD976	367
ARH1599CHDO	299	CL1776DO	421	PD976PT	367
ARH1599CHPT	299	CL1776PT	421	PD1077-CH	347
ARH1599DO	299	CL1837DOMD	149	PD1081	327
ARH1599PT	299	CL1837PTMD	149	PD1083	327
ARH1599TRDO	299	CLSH1575DO	73	PD1127	413
ARH1599TRPT	299	CLSH1575PT	73	PD1128	413
ARSH1568DO	71	CNH1902DO	298	PD1138	405
ARSH1568PT	71	CNH1902PT	298	PD1139	405
ARSH1569DO	71	CUP001BG	467	PD1140	405
ARSH1569PT	71	CUP001BR	467	PD1235	359
ARSH1570DO	72	CUP001FD	467	PD1235PT	359
ARSH1570PT	72	CUP001PT	467	PD1236	359
BA001CR	451	CUP002BG	467	PD1236PT	359
BA001DO	451	CUP002BR	467	PD1237	359
BA002	452	CUP002FD	467	PD1262	252
BA003	453	CUP002PT	467	PD1269	249
BA004	454	CUP003BG	468	PD1269BR	249
BA005	455	CUP003BR	468	PD1290-CO	353
BA006	456	CUP003FD	468	PD1290-CR	353
BA007	457	CUP003PT	468	PD1291-CO	353
BA008	458	CUP004BG	468	PD1291-CR	353
BA009	459	CUP004BR	468	PD1298	251
BA010	452	CUP004FD	468	PD1298G	251
BA011	460	CUP004PT	468	PD1310-CA	399
BA012	461	CUP006	467	PD1310-PT	399
BA013	462	LM860-BR	383	PD1329BZ	333
BA015	463	LM860-PT	383	PD1329BZ-BR	333
BA016	464	LM1060-AE	388	PD1330CH	343
BA017	465	LM1060-CO	388	PD1331CH	343
BA018MD	449	LM1489	147	PD1331FM	343
BA018PT	449	LM1489DO	147	PD1333BZ	331
BA019MD	447	LM1601	147	PD1333BZ-BR	331
BA019PT	447	LM1601DO	147	PD1333PT	331

INDEX

por referência

PD1333PT-BR	331	PD1488DO	143	PD1632DO	153
PD1334BZ	332	PD1488PT	143	PD1633	153
PD1334BZ-BR	332	PD1491	143	PD1633DO	153
PD1334PT	332	PD1491DO	143	PD1637	65
PD1334PT-BR	332	PD1494	55	PD1638DO	320
PD1347	336	PD1495	55	PD1638PT	320
PD1347BR	336	PD1496DO	303	PD1639DO	307
PD1401	163	PD1496PT	303	PD1639PT	307
PD1407	50	PD1497DO	303	PD1641DO	323
PD1407BR	50	PD1497PT	303	PD1641PT	323
PD1420	312	PD1498	144	PD1642DO	132
PD1423BR	198	PD1498DO	144	PD1642PT	132
PD1423CO	198	PD1501A	137	PD1643DO	225
PD1423DO	198	PD1501ADO	137	PD1643PT	225
PD1423PT	198	PD1502A	138	PD1645DO	159
PD1424BR	197	PD1502ADO	138	PD1645PT	159
PD1424CO	197	PD1505	166	PD1650DO	31
PD1424DO	197	PD1508DO	133	PD1651DO	31
PD1424PT	197	PD1508PT	133	PD1652BR	218
PD1425DO	205	PD1509	131	PD1652DO	218
PD1425PT	205	PD1510	131	PD1652PT	218
PD1427DO	206	PD1512	69	PD1654BR	218
PD1427DO	206	PD1514DO	262	PD1654DO	218
PD1427PT	206	PD1514PT	262	PD1654PT	218
PD1429CH	346	PD1516	46	PD1658DO	161
PD1429CO	346	PD1518	107	PD1659DO	161
PD1429FM	346	PD1519	107	PD1661	56
PD1430BR	247	PD1520	108	PD1667DO	329
PD1430CH	247	PD1521BR	321	PD1667OX	329
PD1430PTBR	247	PD1521DO	321	PD1668DO	329
PD1430PTTR	247	PD1521PT	321	PD1668OX	329
PD1431BR	248	PD1522BR	321	PD1674BR	257
PD1431CH	248	PD1522DO	321	PD1674DO	257
PD1432DO	357	PD1522PT	321	PD1674PT	257
PD1432PT	357	PD1610	146	PD1675BR	258
PD1434	348	PD1610DO	146	PD1675DO	258
PD1440	125	PD1611DO	155	PD1675PT	258
PD1441	125	PD1611PT	155	PD1677	41
PD1442	123	PD1612	415	PD1678	167
PD1443	127	PD1613	416	PD1679	167
PD1448	313	PD1614	243	PD1680DO	175
PD1449	313	PD1615	243	PD1680PT	175
PD1451	314	PD1616	241	PD1681DO	176
PD1452	315	PD1617BR	213	PD1681PT	176
PD1455	38	PD1617DO	213	PD1682DO	301
PD1455DO	38	PD1617PT	213	PD1683DO	301
PD1455PT	38	PD1626BR	208	PD1684DO	309
PD1461	259	PD1626DO	208	PD1684OX	309
PD1464	341	PD1626PT	208	PD1686DO	119
PD1465	341	PD1627BR	177	PD1686OX	119
PD1472	44	PD1627DO	177	PD1688DO	61
PD1473	53	PD1627PT	177	PD1688OX	61
PD1475	54	PD1629BR	155	PD1691BR	181
PD1484DO	135	PD1629DO	155	PD1691DO	179
PD1484PT	135	PD1629PT	155	PD1691PT	181

PD1692BR	181	PD1767	33	PD1823DO	171
PD1692DO	179	PD1768	33	PD1823PT	171
PD1692PT	181	PD1769	33	PD1825	85
PD1697	11	PD1773	15	PD1826	87
PD1698	11	PD1774	16	PD1827	87
PD1699	59	PD1777DO	199	PD1829	89
PD1700DO	173	PD1777PT	199	PD1830	90
PD1700OX	173	PD1778BR	200	PD1831PT	184
PD1701DO	173	PD1778DO	200	PD1831PTDO	183
PD1701OX	173	PD1779BR	201	PD1831PTMD	183
PD1705	240	PD1779BRAC003	203	PD1832DO	51
PD1708DO	91	PD1779DO	201	PD1835DOMD	150
PD1708OX	91	PD1779DOAC003	203	PD1835PTMD	150
PD1711	36	PD1779PT	201	PD1836DOMD	151
PD1712BR	129	PD1779PTAC003	203	PD1836PTMD	151
PD1712DO	129	PD1780BR	201	PD1859	105
PD1713DO	39	PD1780BRAC004	203	PD1862BR	180
PD1713OX	39	PD1780DO	201	PD1862DO	180
PD1714DO	361	PD1780DOAC004	203	PD1862PT	180
PD1714PT	361	PD1780PT	201	PD1868	101
PD1715	45	PD1780PTAC004	203	PD1882	22
PD1716DO	68	PD1781BR	201	PD16102	146
PD1721DO	362	PD1781BRAC005	203	PD16102DO	146
PD1721OX	362	PD1781DO	201	PDH1330FM	343
PD1723DO	57	PD1781DOAC005	203	PDH1527CHDO	265
PD1723OX	57	PD1781PT	201	PDH1527CHPT	265
PD1724DO	57	PD1781PTAC005	203	PDH1527DO	265
PD1724OX	57	PD1782BR	219	PDH1527PT	265
PD1725DO	245	PD1782DO	219	PDH1527TRDO	265
PD1725PT	245	PD1782PT	219	PDH1527TRPT	265
PD1728	19	PD1784	25	PDH1528CHDO	267
PD1729	23	PD1789	96	PDH1528CHPT	267
PD1729DO	23	PD1790	95	PDH1528DO	267
PD1730	17	PD1791	95	PDH1528PT	267
PD1731	13	PD1792	97	PDH1528TRDO	267
PD1732	27	PD1793	97	PDH1528TRPT	267
PD1733	27	PD1795	106	PDH1530CHDO	271
PD1735BR	185	PD1799	29	PDH1530CHPT	271
PD1735DO	185	PD1800	29	PDH1530DO	271
PD1735PT	185	PD1801	305	PDH1530PT	271
PD1738	111	PD1802	221	PDH1530TRDO	271
PD1739	109	PD1802DO	221	PDH1530TRPT	271
PD1746	115	PD1805	22	PDH1532CHDO	273
PD1747	115	PD1806	21	PDH1532CHPT	273
PD1748	416	PD1808	103	PDH1532DO	273
PD1751	319	PD1808GR	103	PDH1532PT	273
PD1752	318	PD1809	99	PDH1532TRDO	273
PD1753	318	PD1810	99	PDH1532TRPT	273
PD1754	318	PD1811	100	PDH1533CHDO	274
PD1755CH	345	PD1814FD	223	PDH1533CHPT	274
PD1755FM	345	PD1814PT	223	PDH1533DO	274
PD1755TR	345	PD1815FD	223	PDH1533PT	274
PD1756	415	PD1815PT	223	PDH1533TRDO	274
PD1764	93	PD1819	65	PDH1533TRPT	274
PD1765	93	PD1820	220	PDH1534CHDO	283

INDEX

por referência

PDH1534CHPT	283	PDSH1575DO	83	PLH1594CHPT	290
PDH1534DO	283	PDSH1575PT	83	PLH1594DO	290
PDH1534PT	283	PL1609DO	261	PLH1594PT	290
PDH1534TRDO	283	PL1609PT	261	PLH1594TRDO	290
PDH1534TRPT	283	PL1619BR	187	PLH1594TRPT	290
PDH1539CHDO	282	PL1619DO	187	PLH1595CHDO	291
PDH1539CHPT	282	PL1619PT	187	PLH1595CHPT	291
PDH1539DO	282	PL1620BR	187	PLH1595DO	291
PDH1539PT	282	PL1620DO	187	PLH1595PT	291
PDH1539TRDO	282	PL1620PT	187	PLH1595TRDO	291
PDH1539TRPT	282	PL1621BR	188	PLH1595TRPT	291
PDH1552CHDO	275	PL1621DO	188	PLH1596CHDO	293
PDH1552CHPT	275	PL1621PT	188	PLH1596CHPT	293
PDH1552DO	275	PL1622BR	189	PLH1596DO	293
PDH1552PT	275	PL1622DO	189	PLH1596PT	293
PDH1552TRDO	275	PL1622PT	189	PLH1596TRDO	293
PDH1552TRPT	275	PL1623BR	189	PLH1596TRPT	293
PDH1553CHDO	277	PL1623DO	189	PLH1597CHDO	294
PDH1553CHPT	278	PL1623PT	189	PLH1597CHPT	294
PDH1553DO	278	PL1624BR	190	PLH1597DO	294
PDH1553PT	277	PL1624DO	190	PLH1597PT	294
PDH1553TRDO	278	PL1624PT	190	PLH1597TRDO	294
PDH1553TRPT	278	PL1625BR	190	PLH1597TRPT	294
PDH1559CHDO	279	PL1625DO	190	PLH1598CHDO	295
PDH1559CHPT	279	PL1625PT	190	PLH1598CHPT	295
PDH1559DO	279	PL1644DO	225	PLH1598DO	295
PDH1559PT	279	PL1644PT	225	PLH1598PT	295
PDH1559TRDO	279	PL1656BR	227	PLH1598TRDO	295
PDH1559TRPT	279	PL1656PT	227	PLH1598TRPT	295
PDH1576CHDO	266	PL1662BR	233	PLH1905CHDO	297
PDH1576CHDO	266	PL1662DO	233	PLH1905CHPT	297
PDH1576CHPT	266	PL1662PT	233	PLH1905DO	297
PDH1576PT	266	PL1663BR	233	PLH1905PT	297
PDH1576TRDO	266	PL1663DO	233	PLH1905TRDO	297
PDH1576TRPT	266	PL1663PT	233	PLH1905TRPT	297
PDH1581CH	339	PL1664	231	PLSH1561LED1DO (127V)	77
PDH1581FM	339	PL1665	117	PLSH1561LED1PT (127V)	77
PDH1582CH	339	PL1666	232	PLSH1561LED2DO (220V)	77
PDH1582FM	339	PL1710	35	PLSH1561LED2PT (220V)	77
PDH1586DO	63	PL1749	229	PLSH1562LED1DO (127V)	77
PDH1586PT	63	PL1750	229	PLSH1562LED1PT (127V)	77
PDSH1566LED1DO (127V)	75	PL1759	235	PLSH1562LED2DO (220V)	77
PDSH1566LED1PT (127V)	75	PL1760	235	PLSH1562LED2PT (220V)	77
PDSH1566LED2DO (220V)	75	PL1761	236	PLSH1563LED1DO (127V)	78
PDSH1566LED2PT (220V)	75	PL1796	237	PLSH1563LED1PT (127V)	78
PDSH1567LED1DO (127V)	75	PL1797	238	PLSH1563LED2DO (220V)	78
PDSH1567LED1PT (127V)	75	PLH1593CHDO	289	PLSH1563LED2PT (220V)	78
PDSH1567LED2DO (220V)	75	PLH1593CHPT	289	PLSH1564LED1DO (127V)	78
PDSH1567LED2PT (220V)	75	PLH1593DO	289	PLSH1564LED1PT (127V)	78
PDSH1572DO	81	PLH1593PT	289	PLSH1564LED2DO (220V)	78
PDSH1572PT	81	PLH1593TRDO	289	PLSH1564LED2PT (220V)	78
PDSH1573DO	81	PLH1593TRPT	289	PLSH1588DO	79
PDSH1573PT	81	PLH1594CHDO	290	PLSH1588PT	79

PLSH1589DO	79	QCL1467AE	395	QPD131412	403
PLSH1589PT	79	QCL1467BR	395	QPD131418	403
QAB914-BG	445	QCL1467CO	395	QPL13154	403
QAB914-PT	445	QCL1467PT	395		
QAB916-BG	446	QLM1064-AE	391		
QAB916-PT	446	QLM1064-BR	391		
QAB1066-DO	443	QLM1064-CO	391		
QAB1067-BR	443	QLM1064-PT	391		
QAB1067-PT	443	QLM1160-BR	387		
QAB1068-DO	444	QLM1160-PT	387		
QAB1069-BR	444	QPD919-CO	409		
QAB1069-PT	444	QPD919-PT	409		
QAB1323CH	337	QPD1063-AE	392		
QAB1323FM	337	QPD1063-BR	392		
QAB1325CH	360	QPD1063-CO	392		
QAB1325FM	360	QPD1063-PT	392		
QAB1335CH	439	QPD1158-BR	386		
QAB1335FM	439	QPD1158-PT	386		
QAB1374CO	440	QPD1161-BR	381		
QAB1374DO	440	QPD1161-MR	381		
QAB1375CO	440	QPD1161-PT	381		
QAB1375DO	440	QPD1163-BR	363		
QAB1454PT	441	QPD1163-PTDO	363		
QAR1153-BR	386	QPD1279-CO	351		
QAR1153-PT	386	QPD1279-CR	351		
QAR1154-BR	390	QPD1301-BR	195		
QAR1154-CZ	390	QPD1301-CO	195		
QAR1281-CO	351	QPD1301-DO	195		
QAR1281-CR	351	QPD1301-PT	195		
QAR1337BR	375	QPD1303-BR	196		
QAR1337CR	375	QPD1303-CO	196		
QAR1337PT	375	QPD1303-DO	196		
QAR1349	401	QPD1303-PT	196		
QAR1349DO	401	QPD1321BR	209		
QAR1350	402	QPD1321CO	209		
QAR1350DO	402	QPD1321DO	209		
QAR1351	402	QPD1321PT	209		
QAR1351DO	402	QPD1324CH	337		
QAR1436BR	193	QPD1339BR	207		
QAR1436CO	193	QPD1339CO	207		
QAR1436DO	193	QPD1339DO	207		
QAR1436PT	193	QPD1348CH	360		
QAR1454BR	441	QPD1361CO	397		
QAR1457AE	393	QPD1361DO	397		
QAR1457CO	393	QPD1361PT	397		
QAR1457PT	393	QPD1435BR	191		
QAR1458AE	388	QPD1435CO	191		
QAR1458-CO	388	QPD1435DO	191		
QAR1466BR	394	QPD1435PT	191		
QAR1466PT	394	QPD13224	400		
QAR1483-PT	363	QPD13224DO	400		
QAR1483-PTDO	363	QPD13229	400		
QCL1152-PT	385	QPD13229DO	400		

studioluce.com.br



@studioluceiluminacao



/studioluceiluminacao



/@studioluceiluminacao



Studioluce
ILUMINAÇÃO